



Investigation of a L1-optimized Choke Ring Ground Plane for a Low-Cost GPS Receiver-System

Workshop on Cost Effective Positioning and Geo Data

Li Zhang, Volker Schwieger

Institute of Engineering Geodesy (IIGS), University of Stuttgart, Germany

20th April 2017, Novosibirsk, Russia



Introduction

Monitoring is one of the main tasks of engineering geodesy.

Disadvantages of the GNSS receivers :

- **Cost:** the geodetic receiver are expensive (partly > 20 000 €)

➔ **Low-Cost single-frequency GPS Receiver** (e.g. u-blox < 100 €)

- Accuracies of sub-cm can be achieved with Low-Cost GPS receivers, if the carrier phase measurements are evaluated in relative mode and the length of the baseline is up to several kilometres (influences of baseline-length-dependent errors can be mitigated).
- Typical monitored objects, e.g. dams, bridges, landslides: extension ~several km!

➔ **Low Cost GPS receivers are suitable for Monitoring applications!**

- **Quality:** influenced by multipath effects (**dominant error** for short baselines)

**Goal: Improving Quality of Low-Cost-GPS Receiver Data
for Monitoring applications!**

Motivation

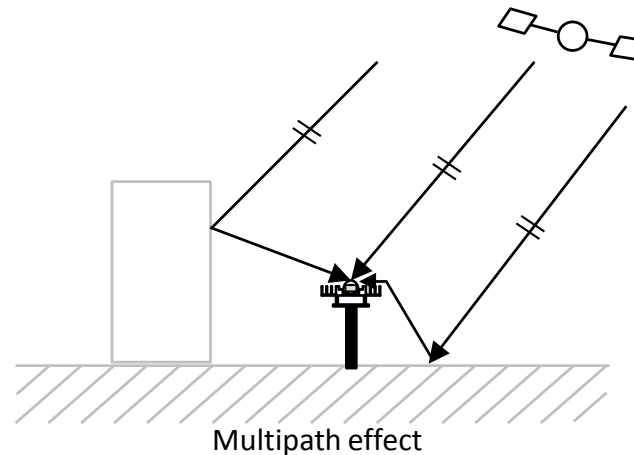

Two Solutions to reduce the influence of the multipath effect:

- self-constructed L1-optimized choke rings („**Hardware**“)
- two coordinate-based methods by considering the temporal and spatial correlations of closely-spaced Low-Cost GPS Antennas („**Software**“)



Structure

- ✓ **Introduction and Motivation**
- **Optimization of Antenna Shieldings**
 - Design of L1-optimized Choke Ring Ground Plane
 - Antenna Calibration
- **Comparison of different Shieldings**
 - Test Scenario
 - Data Processing
 - Quality Analysis
 - Frequency Analysis
- **Conclusion and Outlook**

Optimization of Antenna Shieldings

Design of L1-optimized Choke Ring Ground Plane

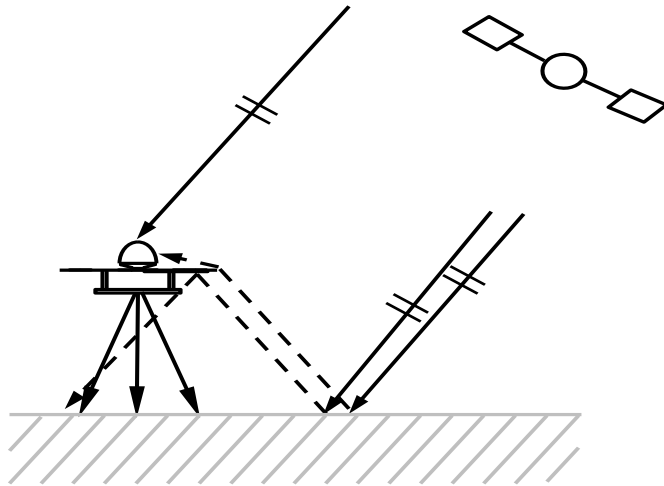

Antenna with flat ground plane

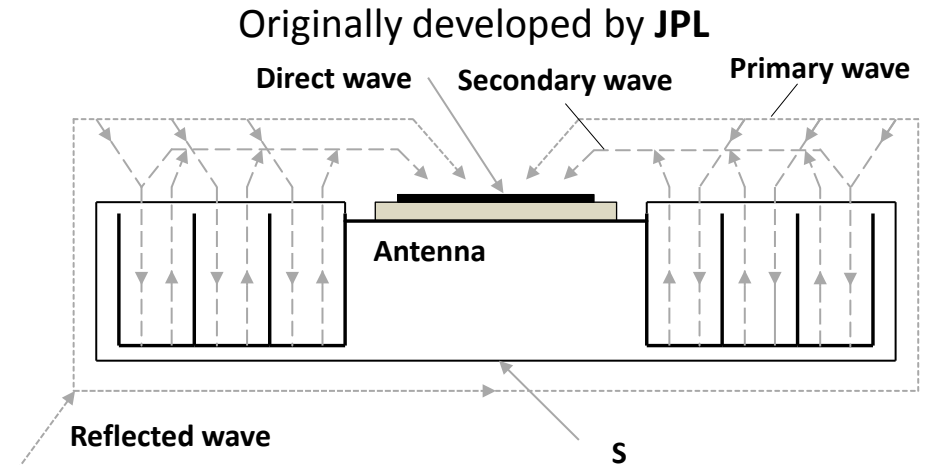

Principle of choke ring (after Filippov et al. 1998)

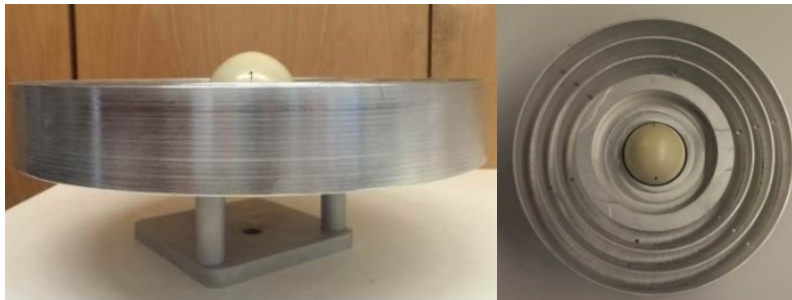

self-constructed CR-GP with antenna (side view and top view)

- Groove depth: $\frac{1}{4}$ of wave length
 - L1-optimized: ca. 47mm
 - Commercial: 50 mm to 56mm
- Diameter: 1,5 of wave length
 - L1-optimized: ca. 300 mm
 - Commercial: 360 mm to 380 mm

Optimization of Antenna Shieldings

Antenna Calibration



Calibration of TBIII antenna with flat Ground Plane and Choke Ring Ground Plane

PCV of TBIII antenna
with flat ground plane [mm]

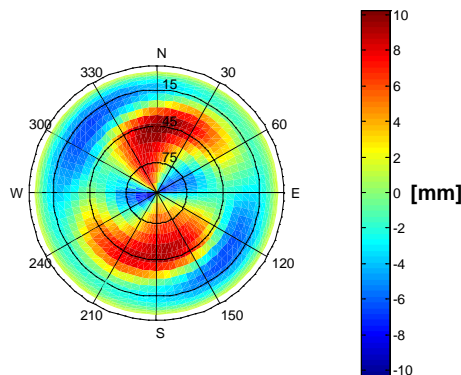

PCV of TBIII antenna
with choke ring ground plane [mm]

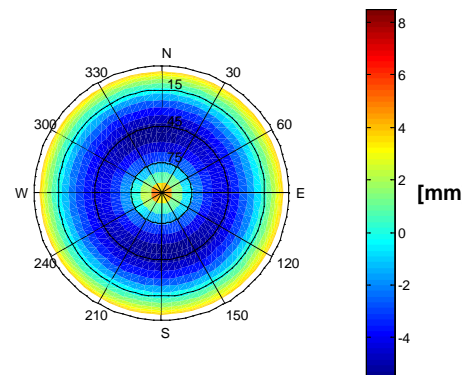

PCV with Choke Ring Ground Plane:

- smaller and more homogeneous
- Difference of the PCV between antenna: -1,5 mm to 1,5 mm → type antenna calibration is sufficient

PCV of TBIII antenna with flat Ground Plane and Choke Ring Ground Plane

Comparison of different Shieldings

Test Scenario

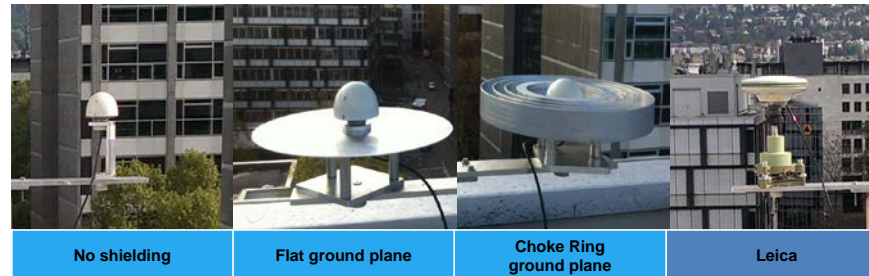

Four combinations of antenna-shieldings

- 1) TBIII antenna without shielding + Ublox LEA-6T single-frequency GPS receiver,
- 2) TBIII antenna with flat GP + Ublox LEA-6T single-frequency GPS receiver,
- 3) TBIII antenna with CR-GP + Ublox LEA-6T single-frequency GPS receiver,
- 4) Leica AX1203 GNSS antenna without additional shielding + Leica GX1230 GNSS receiver.

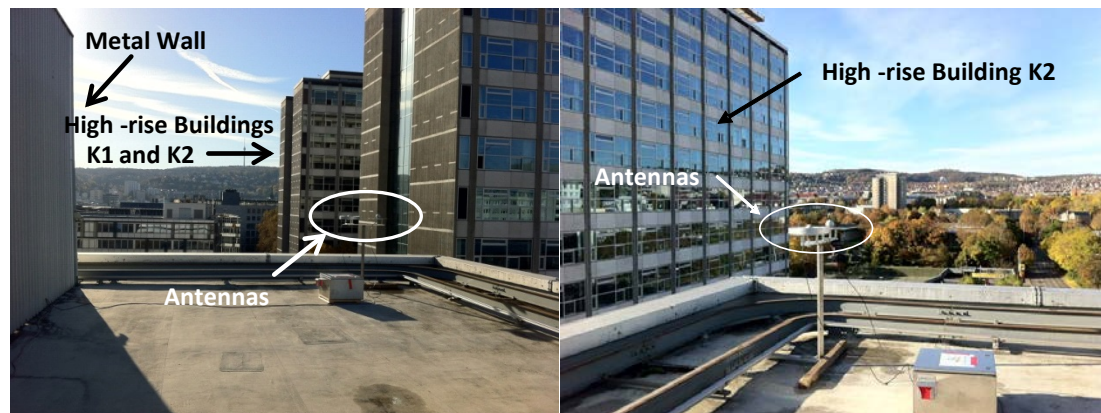

Photos of Test Field

Comparison of different Shieldings

Test Scenario

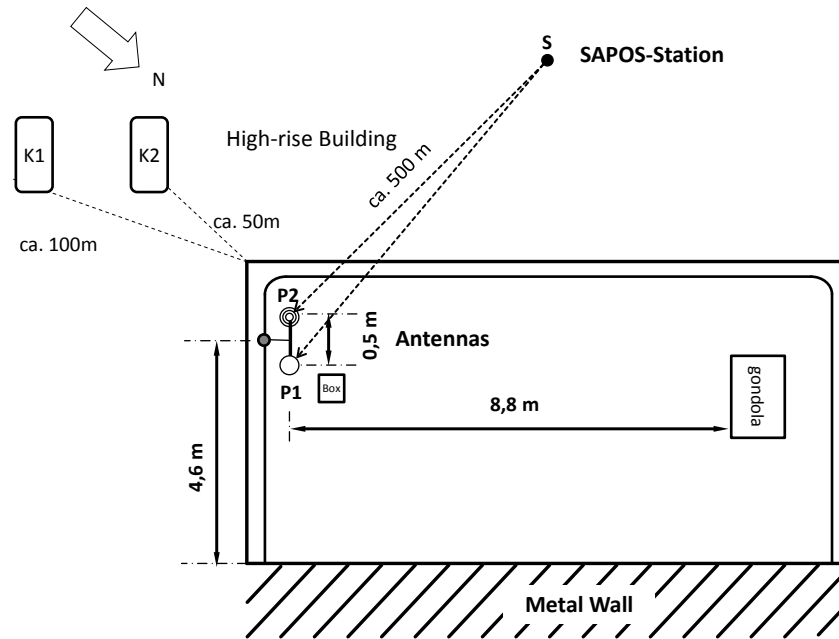

Session Nr.	Date	Antenna and Shieldings	
		P1	P2
1	24.-25. 10.13	TBIIII+ CR-GP	TBIIII+ flat GP
2	27.-28. 10.13	TBIIII+ flat GP	TBIIII+ CR-GP
3	26.-27. 04.14	Leica AX1203	TBIII without shielding
4	27.-28. 04.14	TBIII without shielding	Leica AX1203

Comparison of different Shieldings

Data Processing

Session Nr.	Observation time (GPS-Time)
1	24.10.13 10:30:30 - 25.10.13 06:30:29
2	27.10.13 10:17:18 - 28.10.13 06:17:18
3	26.04.14 21:51:06 - 27.04.14 17:51:05
4	27.04.14 21:47:00 - 28.04.14 17:46:59

- 20 hours are cut from the original observation time for the data processing
- averaged satellite period was considered (23 hours 55 minutes 54 seconds)



Results: baseline in UTM-system (East, North, Height)

sampling rate 1 Hz → every second



Comparison of different Shieldings

Quality Analysis

Receiver		Ubox LEA-6T GPS-L1-Receiver			Leica GX1230 GNSS-Receiver		
Antenna		Trimble Bullet III			Leica AX1203		
Shielding		-	GP	CR-GP	-	-	
Frequency		GPS-L1	GPS-L1	GPS-L1	GPS-L1	GNSS	
Quality	Reliability (Percentage of Outliers)	O_E [%]	4.2	2.4	2.1	1.7	1.4
		O_N [%]	4.6	3.0	2.6	2.7	1.4
		O_h [%]	4.0	2.8	2.1	2.3	1.4
		O_m [%]	4.2	2.7	2.3	2.2	1.4
	Accuracy (Standard Deviation- 1σ)	s_E [mm]	6.8	5.6	3.4	3.8	3.5
		s_N [mm]	10.1	7.9	4.9	5.5	4.8
		s_h [mm]	16.7	13.3	8.7	9.8	10.1
		s_p [mm]	20.7	16.4	10.5	11.9	11.7

Results of Quality Analysis of antenna-shielding test (mean of P1 and P2)

Comparison of different Shieldings

Quality Analysis

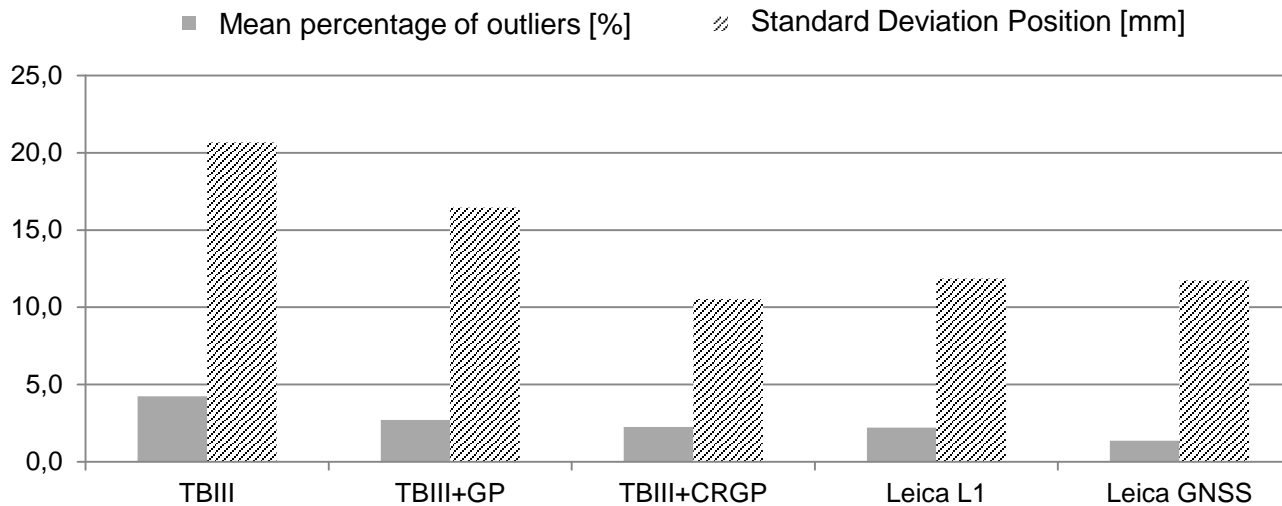

Quality Analysis of antenna-shielding test (mean of P1 and P2)

- Improvement of the standard deviation: CR-GP: ca. 50 %, Flat GP: 35 %
- TBIII antenna with CR-GP can achieve a standard deviation of ca. 3 mm in east, 5 mm in north and 9 mm in height in this reflexion intensive environment.
- TBIII antenna with CR-GP has shown in this test a result, which is comparable with Leica AX 1203 antenna with GX1230 receiver



Comparison of different Shieldings

Frequency Analysis

- Frequency of multipath on the carrier phase

$$f_{\delta\varphi}(t) = \frac{2}{\lambda} \cdot \begin{cases} h \cdot \cos E^s(t) \cdot \dot{E}^s(t) & \text{Horizontal} \\ -d \cdot \sin E^s(t) \cdot \dot{E}^s(t) & \text{Vertical} \end{cases}$$

- λ : wavelength (L1:19 cm)
- h and d : vertical and horizontal distances between antenna and reflector
- E^s and \dot{E}^s : elevation of the satellite and its change over time (velocity)

- Period (of coordinates' time series) caused by the multipath effects in this test field:

- by the ground : period >20 minutes or frequency < 0.83 mHz
- by metal wall: period 5-30 minutes or frequency 0.55-3.3 mHz
- ➔ Generally: frequency which is **less than 0.55 mHz** is mainly caused by multipath signals from the ground

Comparison of different Shieldings

Frequency Analysis

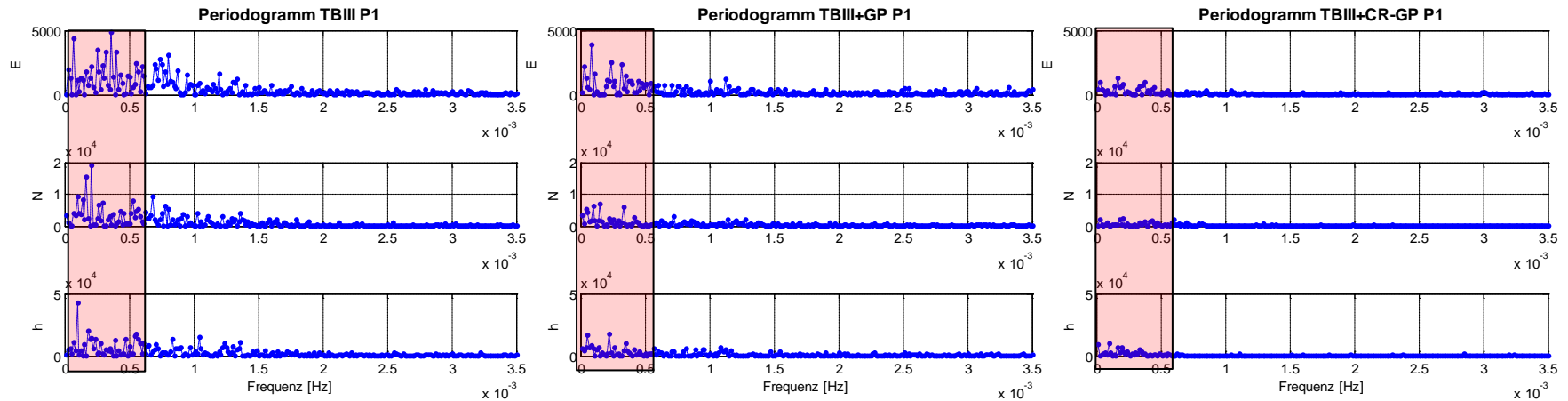

Periodogramm of coordinates' time series of TBIII antenna: without shielding, with flat GP, with CR-GP on point P1

By applying the shielding, the energy between the 0 and 0.55 mHz is reduced considerably, and CR-GP reduced even more energy than the flat GP.

➔ Shieldings reduced mainly the signal from the ground and the CR-GP is more effective than the flat GP.



Conclusion and Outlook

Conclusion

- Description of the Design of a L1-optimized choke ring ground plane (CR-GP)
- Results of antenna calibration: PCV of the TBIII antenna with CR-GP are smaller and more homogenous than with flat GP. No individual antenna calibration of TBIII antenna with CR-GP necessary
- CR-GP is the best shielding, improvement of the standard deviation by using CR-GP is about 50 % and 35 % by using flat GP
- The standard deviation of TBIII antenna with CR-GP is 3 mm in east, 5 mm in north and 9 mm in height in the test field which has many reflectors. The TBIII antenna with CR-GP shows in the test reliable and accurate results, which is comparable to the Leica AX 1203 GNSS antenna with GX1230 GNSS receiver.
- The frequency analysis shows that the shieldings reduce mainly the multipath signal from the ground and the CR-GP is more effective than the flat GP.



Conclusion and Outlook

Limitation:

- CR-GP is not for all the application suitable because of its weight
- Single frequency GPS receiver-system has its limitation, if the baseline is long (more than 10 km), and it is also not really suitable for PPP (Precise Point Positioning) up to now, if the accuracy should be in mm or cm level. Because they receive only the L1-frequency, the ionospheric influence cannot be reduced in both cases.

However:

- The introduced low-cost GPS receiver-system (costs up to 1000 €), which contains the Ublox LEA-6T single-frequency GPS receiver and TBIII antenna with self-constructed L1-optimized CR-GP, can already obtain an accuracy in the range of millimetres which meets the requirements of geodetic precise monitoring for such as landslides, bridges and dams and so on.
- The difference of L1-wavelength of GPS, GLONASS, BeiDou, Galileo is not big
→ introduced CR-GP is suitable for multi-GNSS single-frequency receiver!



Thank you very much for your attention !

CONTACTS

Dr.-Ing. Li Zhang/Prof. Dr.-Ing. habil. Volker Schwieger

Institute of Engineering Geodesy, University of Stuttgart

Geschwister-Scholl-Str. 24 D

70174 Stuttgart

Germany

Tel: +49-711-685-84049 / -84040

Fax:+49-711-685-84044

E-mail: li.zhang@ingeo.uni-stuttgart.de/volker.schwieger@ingeo.uni-stuttgart.de