

Data Modelling and Application of 3D Cadastre in Taiwan

Hun-Chin Chiang, Taiwan

Key words: 3D Cadastre, Result map of building survey, Floor plans, Storey planes, 3D Building Model

SUMMARY

Real estate follows a registration system in Taiwan. Property rights guarantee protection once registered. Currently land registration is enforced by the government; while constructional improvement registration is submitted on owner's request. In the metropolitan areas, a majority of owners have applied improvement registrations in order to gain property right protection. The registration initiates the survey of constructional improvements based on its location, construction plan, and building use permit within the property boundary. Upon the survey completion, the result map of building survey will be issued which contains building location maps, storey maps, and floor maps based on property ownership, area, and use permit for the improvements registration. Therefore, Land Office is able to access and permanently archive the cadastral information.

This article describes a practical method conducted by Taiwan Land Office to establish 3D building models that contain property ownership information in each storey. The model integrates the floor plane of each unit to form a storey plane map. Connecting multiple storey maps using the corresponding heights establishes the 3D building model. Doors, windows, and columns may also be allocated in the model by referring to the construction plane of buildings. Hence, a basic 3D model containing detail interior information can be achieved.

The 3D cadastral system has been developed in Taiwan since 2007. In addition to the cadastre data construction, the system has also been utilized in 3D cadastral property management, real estate, urban planning, household management, and is not limited to 3D visualization only. This research has successfully demonstrated the critical steps of model establishment. The results are the foundation of future 3D cadastral data advancement promoted under government policy.

Data Modelling and Application of 3D Cadastral in Taiwan

Hun-Chin Chiang, Taiwan

1. INTRODUCTION

Urbanization has driven population growth centralizing in the metropolitan areas. Modern structures such as high rise buildings and viaducts are difficult to express in 2D. 3D city models on the other hand are able to present much more detail and realistic urban landscape for visualization. Therefore, Cyber City has become an important foundation of city architecture in the 21st century (Li et al, 2004). Traditional land registration information is intended as well as limited to 2D cadastral applications (Ali et al, 2011). In light of the trends in 3D urbanization, cadastral management should also shift towards 3D as development progresses. In recent years, F.I.G.(The International Federation of Surveyors) has strongly advocated the concept of Multipurpose Cadastre (MPC) and 3D Cadastre , which suggests the better use of cadastre data and other spatial information (building information, underground facilities, and 3D city models, etc) that applies to a wider field of applications (Alias et al, 2011, Oosterom et al, 2011).

Building data is the primary information in 3D cadastre management. It contains location, property ownership, and landscapes which possess great influence to real estate value that is of great concern for people's rights. Its importance is further highlighted by the rise of housing prices. 3D building models can be complicated. The Open Geospatial Consortium (OGC) has defined five different levels to describe the level of detail (LOD) of the model fineness. LOD-0 model contains only simple blocks to represent terrain and images. LOD-1 model uses simple blocks that collectively represent buildings. LOD-2 model includes textures and roof structures. LOD-3 model details the building architectures specifying exterior walls and balcony. LOD-4 model describes interior architectures and objects such as inner walls, doors, windows, columns, stairs and furniture (Gröger et al, 2008, Elwannas, 2011).

There is a number of 3D building modelling methods reported in the literature. Due to the variation in data acquisition and modelling techniques, and the differences in requirements and applications, the range of model types is diverse. In general, LOD-1 and LOD-2 models often emphasize on the building structure and appearance. These models often use large scale maps, aeronautical images, or light detection and ranging (LIDAR) techniques to achieve the visualization of Cyber City. LOD-3 and LOD-4 models on the other hand exploit LIDAR or construction drawings to capture the fine details of both exterior and interior architectural structure. LOD-1 and LOD-2 models are limited to building appearance that are applicable to urban landscape, city planning, and design in the metropolitan area. This is the main stream of

current 3D Cyber City developments. However, most interactions between people and buildings are in indoor environments. Property ownerships are also related to the building boundaries. Unfortunately, LOD-3 and LOD-4 data are difficult to obtain and are extensive and expensive. Hence many researches are targeted on expanding the applicability of cadastre data for different domains of applications.

In Taiwan, the 3D cadastre prototype system project has started since 2007 to help protect property ownership. The system exploits the information from the land and building registration to compute a 3D building model which underpins property ownerships. A pilot study was carried out to demonstrate the system applicability for multiple applications including 3D cadastre management, real estate, household management, urban landscape, and is not limited to 3D visual effects only. This article describes the results of this prototype system, which is a first step to promote a 3D cadastre standard in Taiwan.

2. CADASTRAL SYSTEM IN TAIWAN

Taiwan has a land area of approximately 36,000 square kilometers. Land management has adopted the Torrens System and is managed by the Land Administration Department of the Ministry of the Interior, and the Land Administration Bureau of city governments. Land registration is mandatory. There are 14,850 thousand registrations distributed across a total area of 35,000 km², equivalent to 97% of Taiwan's land area. Cadastral mapping began in 1898, while Taiwan was ruled by the Japanese. The land ownership was returned to Taiwan since 1946, and the same measurement results have remained. Cadastral map resurvey has started in 1976 as part of the economic development. Until now the resurvey has completed 549,815 hectare, containing 7,303,023 registrations, approximately 50% of the registered land and an area of 15%. Since 1990 a digital method has been used for the resurvey, and the original graphic cadastral maps have also been digitized and completed in 2007 (Figure 1). The cadastral maps are saved as tables of Data of Land Parcel, Data of Boundary, and Coordinate Data of Corners in Database. Therefore, cadastral measurements are now fully processed in the digital domain. Users may access the data through internet to search for land location, data of land description, land ownership, and information regarding other rights. Due to security reasons, only the land owner is able to request the whole data. The data projection is in TWD97 coordinate system recorded in 2D. The resolution of the digital terrain model is 5m, which enables 2.5D display of the land information.

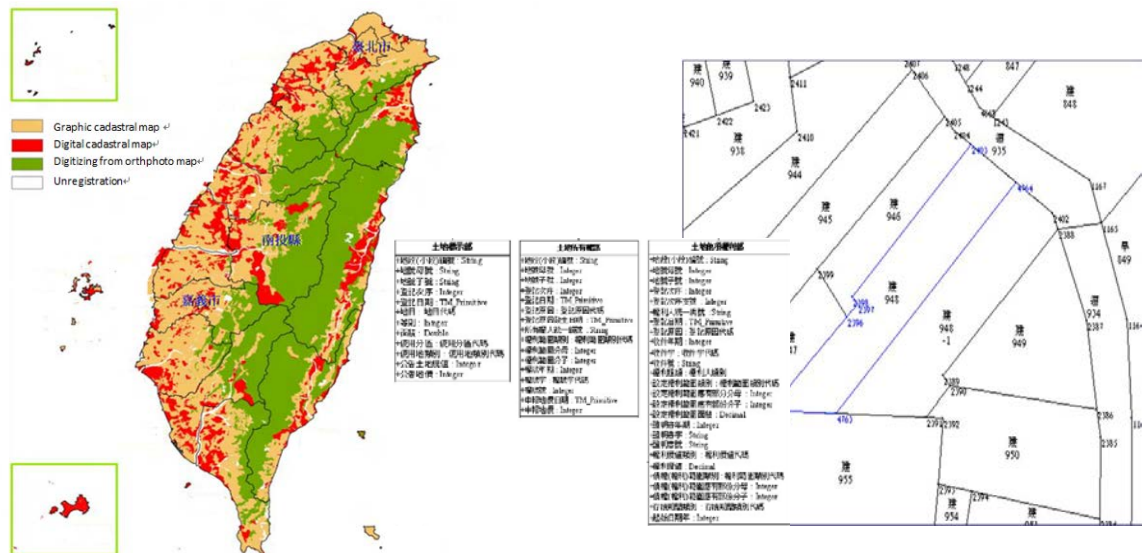

Figure 1. Taiwan Cadastral Survey Status

Building construction and management is carried out by the Construction and Planning Agency of the Ministry of Interior. Application of a building construction requires submission of building lot map to the Public Work Bureau for a construction permit. At the completion of building construction, a construction completed plan must be submitted to apply for a building use license. To register a constructional improvements ownership, the building owner must submit the construction completed plan and building use license to the local land office for an Initial Survey of Constructional Improvements. Upon completion, each building property will be issued a building number and a Result Map of Building Survey (Figure 2), including the building plans, building location, building area calculation formula, and building attributes data. Owner building plans contains the main building, attached building and shared area on separate floors. They are displayed as polygons in a scale of either 1/100 or 1/200 with labelled boundaries. Building location is based on a 1/500 cadastral map with coordinates labelled for each building. Building area calculation formula records the area for each building polygon which is the reference of property right registration. Building attributes data contains document information (application number, application date, applicant, and survey date), building data (building location number, address, main and attached building structure and purpose, use licence number, and area, etc), and result map descriptions, etc. The result map of building survey is used for building registration.

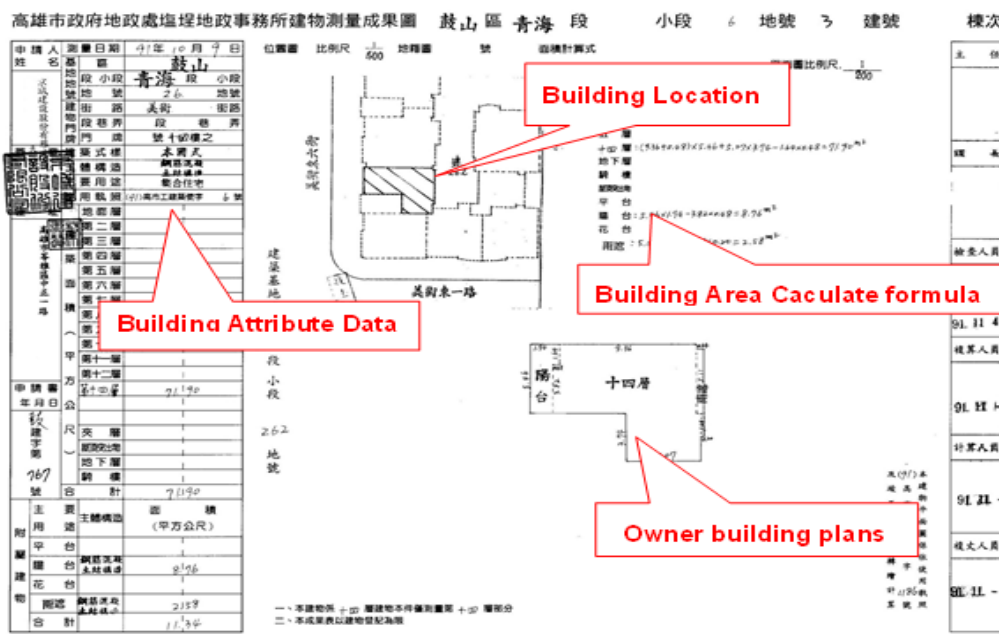

Figure 2. Result map of building survey

The public areas of collective buildings (e.g. apartments) have different building numbers and are shared among each owner. Hence, the Land Office maintains cadastral building data which are registered by application. There are approximately 7.75 million building numbers nation-wide. The total building area has approximately 130,000 km², in which 85% are residential areas. Since 2007, the building planes in the result map of building survey have been conducted and stored in 2D vector format. Drawings prior 2007 have also been digitally scanned and filed.

3. 3D CADASTRAL BUILDING MODEL STRUCTURE

Result map of building survey is bounded by the property title of the building owner. Each result map corresponds to only one building number. A building number may belong to an entire building or one unit of a building. Therefore one building may contain one or more building numbers. The structure of the 3D cadastral model is outlined in Figure 3. The operation process is shown in Figure 4 (Chiang, 2000). The details are explained in the remainder of this section.

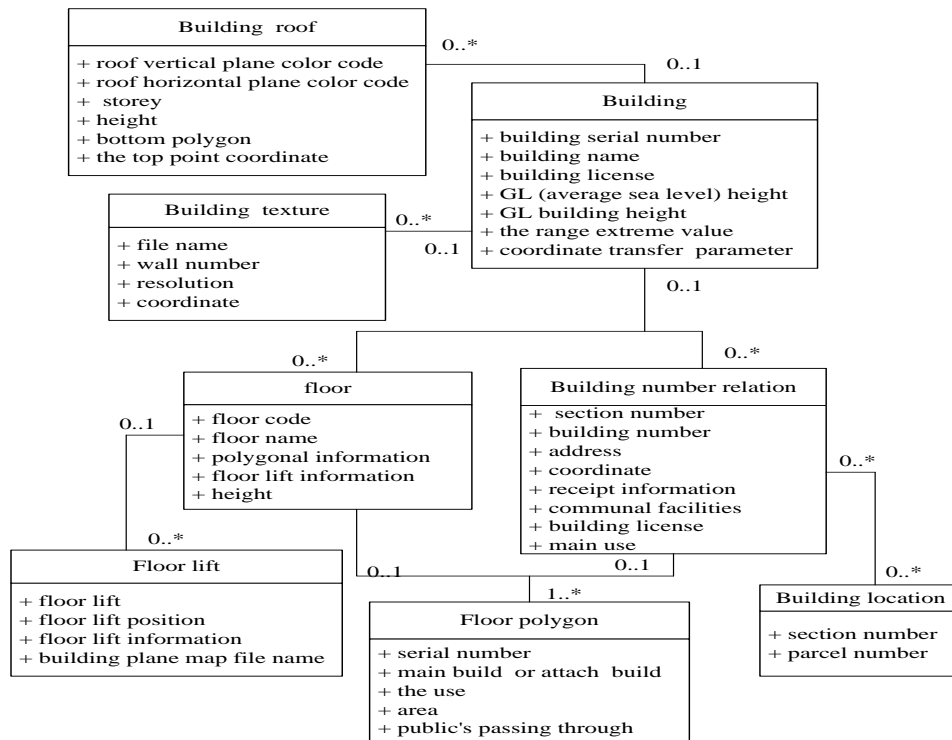

Figure 3. System objects connection

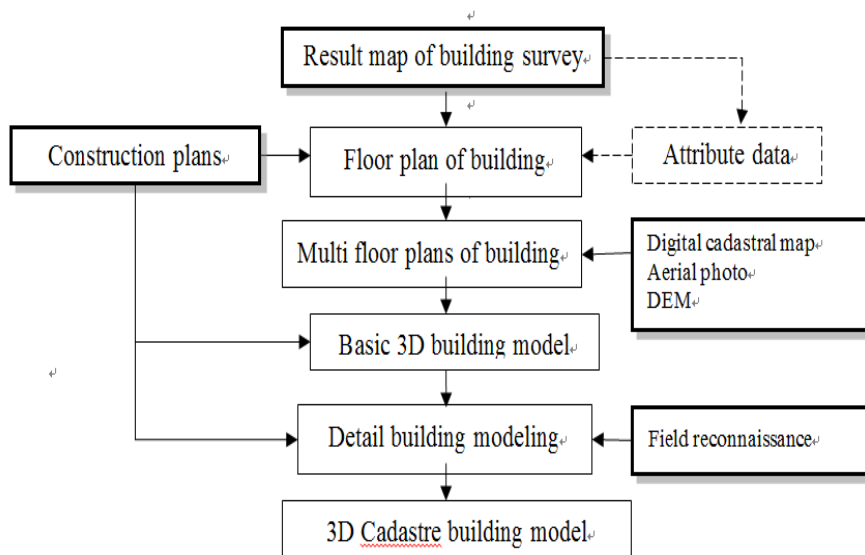

Figure 4. 3D cadastral building model construction process

(1) Establishment of Storey Plane Map

Building plane map is drawn based on each property that corresponds to a building number. The 2D raster floor planes must be transformed into vector polygons. Adjacent polygons are joined together both horizontally and vertically. Alignments are achieved using control points and reference lines under the cadastre coordinate system. Figure 5 depicts the process flow for establishing a vector cadastral storey plane. The process follows the procedure of vector data

construction, building parameter setup, and topologic establishment for the final storey plane.

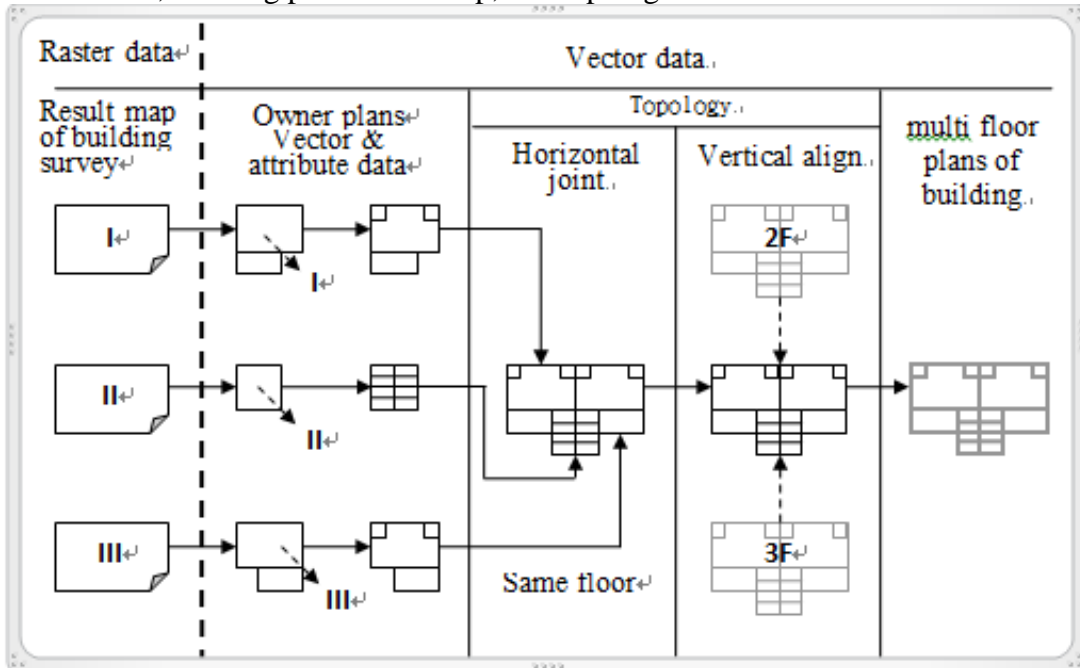

Figure 5. A flow chart for establishing a cadastral building floor plan

Vector storey planes are 2D maps containing storey attributes. Since the topography is already defined during the establishment process, exterior walls, main and attachment walls, and boundary walls (Figure 6) may be used to adjoin multiple floor planes into a storey plane. Storey heights are obtained from the construction planes and the use license. Eventually the planes can be combined and aligned to form a complete 3D cadastre building model (Figure 7). (Chiang, 2009)

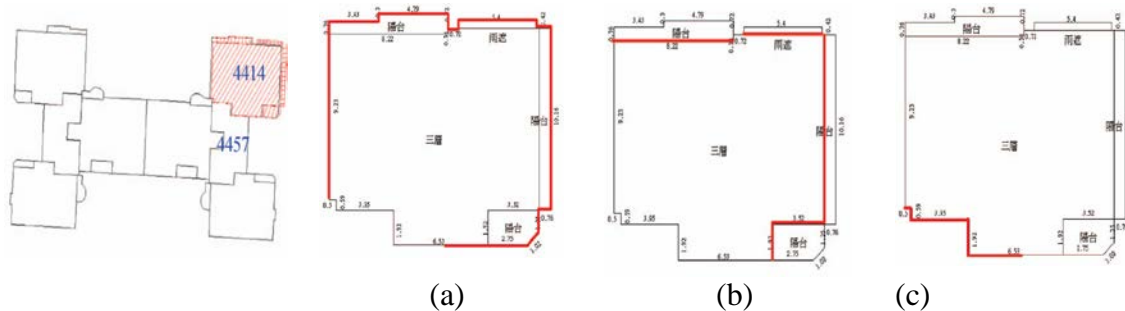

Figure 6. Polygon boundary of building

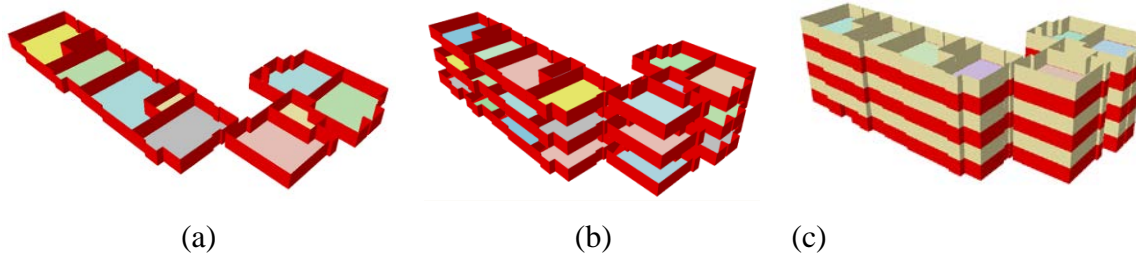

Figure 7. 3D building floor model

CAD processing method is used to construct vector floor planes using either the plane image as background, or the constructional maps as a hard-copy reference. These vectorized floor planes are then consolidated into storey plane maps (Figure 8). Multiple storey planes are aligned (Figure 9) and incorporated with height information to establish a 3D building model (Figure 10).

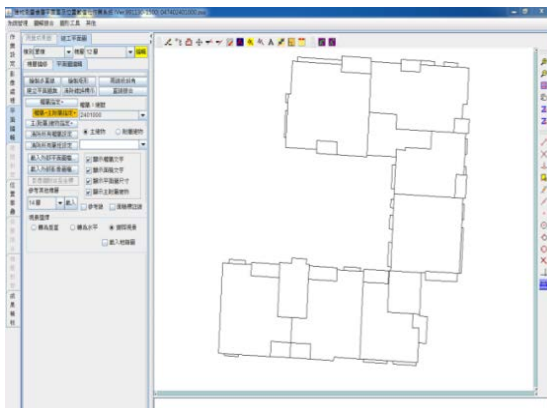

Figure 8. Connection between floor plans

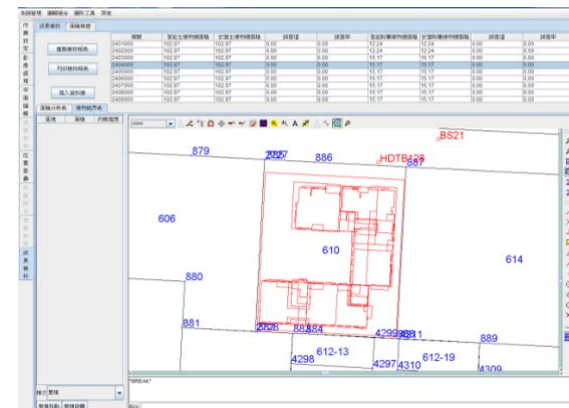

Figure 9. Vertical align between building floors

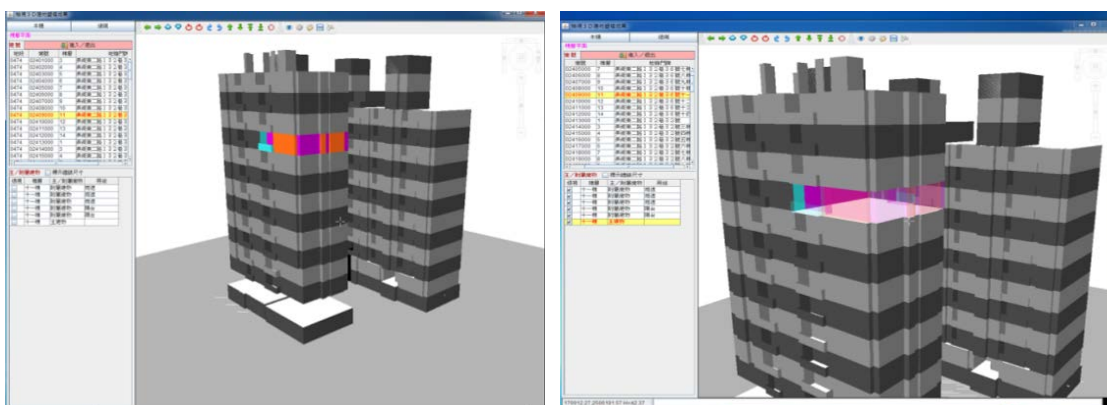

Figure 10. Perspective view of floor property boundary

The final storey plane map contains building number and location, floor polygon, storey information, and storey location. The resultant model may be utilized in conjunction with the

building attributes including data of land registration, data of building ownership, and data of other rights over buildings to enable 3D cadastral building property management.

(2) Establishment of basic 3D cadastral building model

Based on the building components in the CityGML standard, and the contents and features in the result maps of building survey, this research has designed ten building components to describe the cadastral building model, including “3D building”, “3D floor”, “wall”, “door”, “window”, “eaves”, “balcony”, “stairs and elevator”, and “column” as shown in Figure 11.(Chang,2010)

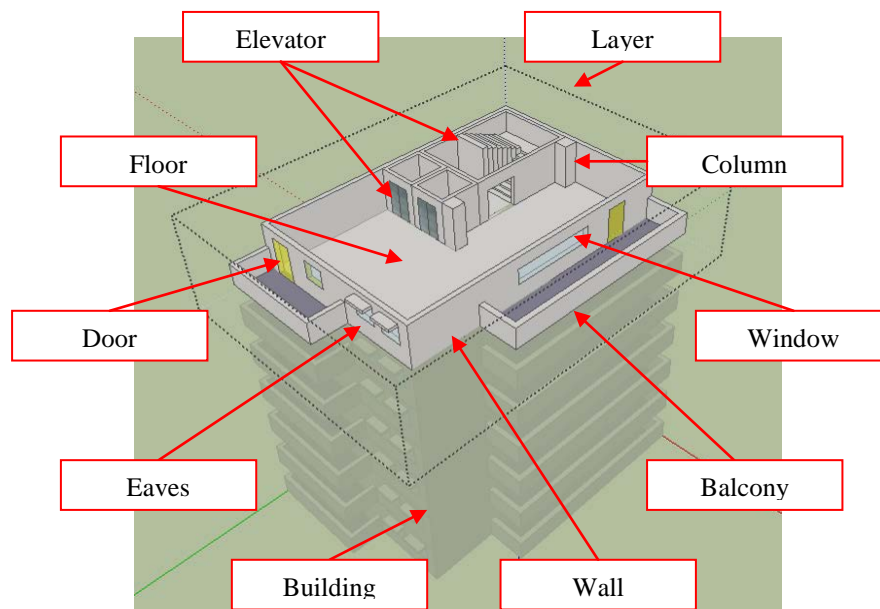

Figure 11. Illustration of main components of cadastral building model

Table 1. Classification of cadastral building components

main component	Layer name	Attached building	Layer name
layer*	_00*_	machine room	machine room
Under layer*	B00*_	parking area	parking area
Roof *Storey	R00*_	arcade	arcade
floor	floor	roof	roof
column	column	balcony-expose	balcony-expose
stair	stairs	balcony-flat	balcony-flat
wall	wall	balcony-flower	balcony-flower
wall-inner	wall-inner	electric room	electric room
window	window	storeroom	storeroom
door	door	water tank	water tank
elevator	elevator	water tower	water tower
balcony	balcony	flower bed	flower bed
eaves	eaves		

The detail floor planes comprised of room polygons and inner walls. Storey heights can be

obtained from the construction planes or via measurements, which are incorporated to form a 3D interior model. Locations and dimensions of doors and windows on the main and attachment walls are determined using the same method. Door and window types are defined depending on the building usage on both sides (Figure 12). Component placement in respect to the wall locations can be setup using parameters including wall end-points (P1, P2), distance to wall (d1), height to wall (h1), width of door/window (d2), and height of door/window (h2).

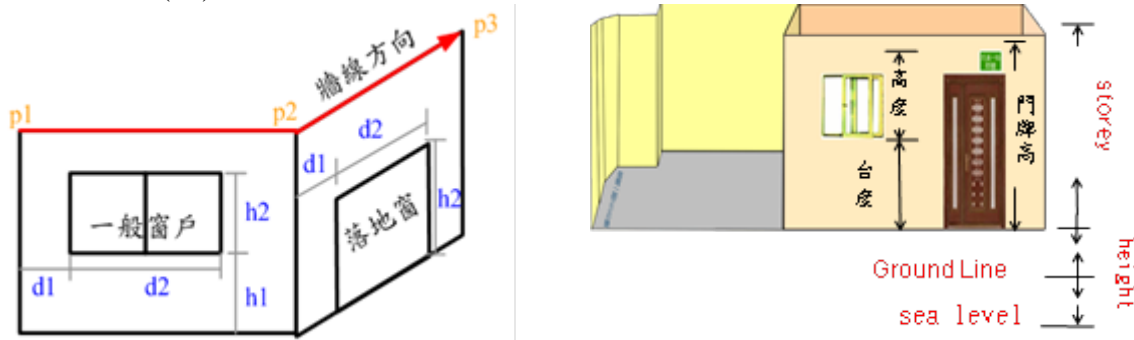

Figure 12. Doors and windows placement rules

Door, windows, and exterior walls can be displayed using materials from the existing templates. Building and eaves can be presented using different colors. If greater level of detail or more realistic material is needed, textures of exterior walls, balcony, doors and windows can be extracted from photographs. Figure 14 – 15 show the results of the basic 3D cadastral building model.

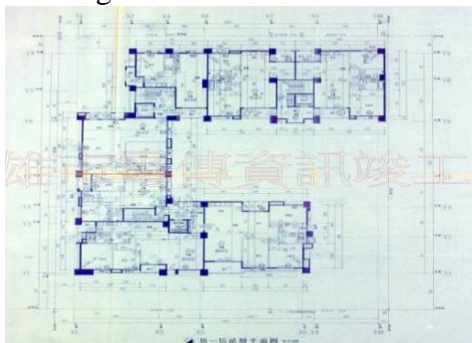

Figure 13. Construction plane maps

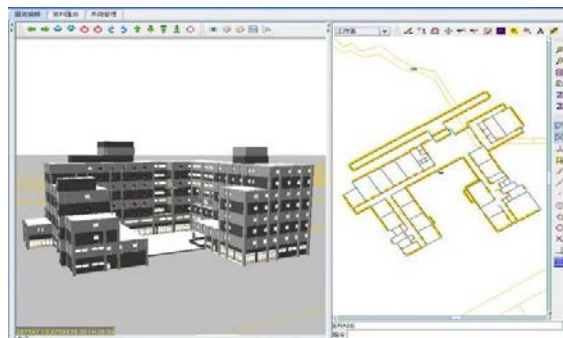
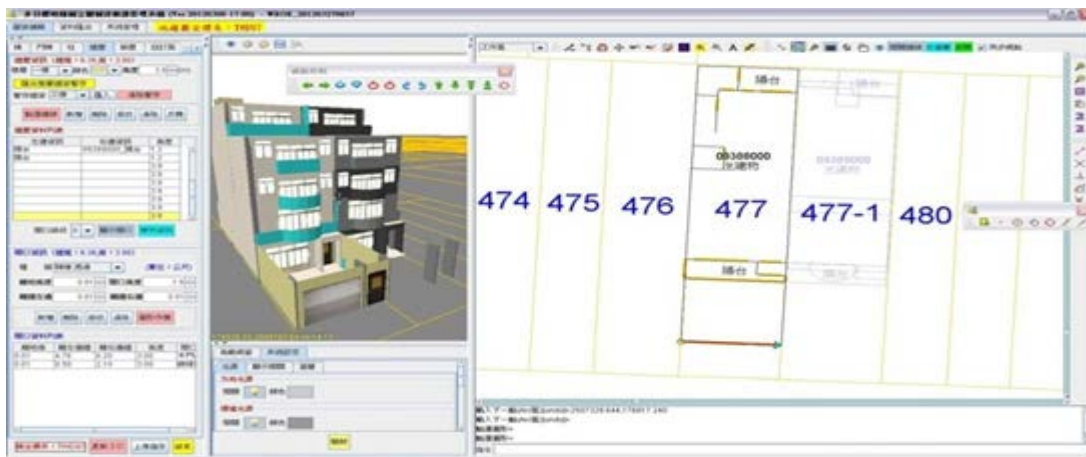

Figure 14. Building model with doors and windows completed



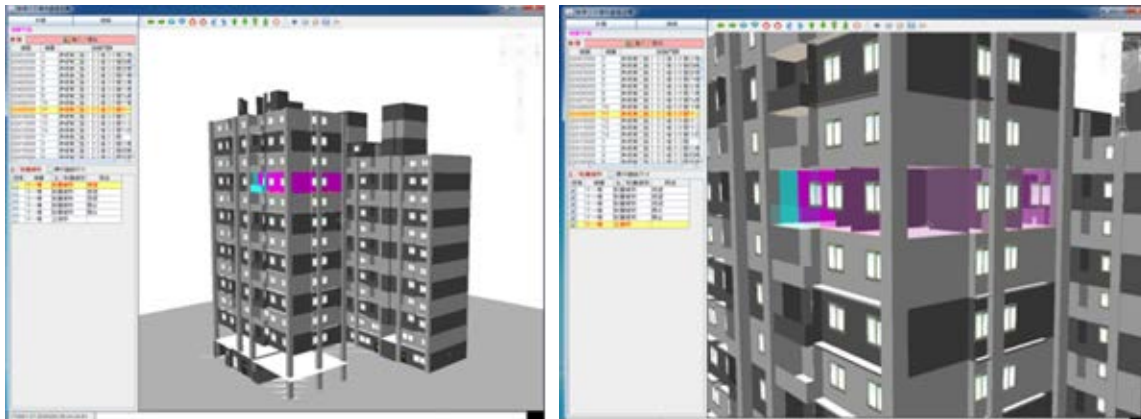

Figure 15. Perspective view of property boundary in 3D basic Mode

The final basic 3D cadastral building model contains the following information which is organized in separate directories: Building number data; storey ID; columns; 3D graphical data; 3D surface and texture; building stairs; floor stairs; horizontal planes and textures; vertical planes and textures; floor information; building number and location; storey polygon; view point; and interior walls.

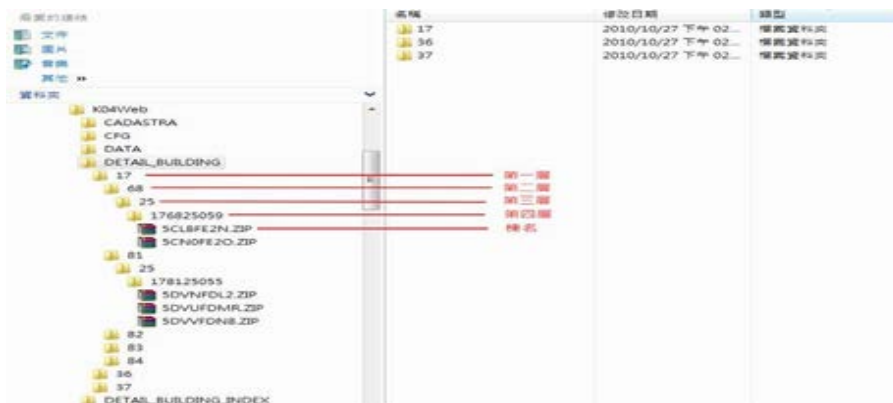

Figure 16. Building model file structure

Thus, additional to the 3D cadastre property management, and real estate evaluation, the model developed also enables household management and building security management since all the addresses have been established. The model may be further utilized in other value added applications such as pipe line design, building fire route planning, etc.

(3)Detail 3D building model

If detail building models are required, additional survey or interior drawings are required for texture processing. Figure 17 shows the result of a detail building model. To allow 3D data exchange and multipurpose applications, the developed system may output the data as SketchUp format for further 3D data editing. The resultant data are suitable for web-based 3D platforms such as Google Earth or Skyline. The intelligent features and simple drawing procedures of SketchUp permit the users to concentrate on the actual design for maximum efficiency. This gives the users the opportunity to perform detail building component editing that includes object thickness, layer classification, parameters, etc, to achieve realistic models

of the floor, wall, roof, window, door, and stairs, etc. The resultant model is also easy for maintenance and expansions. Figure 18 shows the completed detail 3D building model.



Figure 17. Detail interior building model



Actual building image



SketchUp building model after texture editing



Figure 18. SketchUp detail 3D interior model (Land Office)

4. 3D CADASTRE PROTOTYPE SYSTEM

This research is commissioned by the government since 2007 to investigate the feasibility of a 3D cadastre system. Initially a 3D building model is developed, which then evolved into a multipurpose cadastre 3D information system. Graphical data and property right attributes are directly linked to the National Lands Information System. The process is described as follows.

4.1 System Development

1) 3D cadastre modelling system

Existing result map of building surveys are mostly stored in image format (stored as vector format since 2007), hence they need to be vectorized to achieve the 3D building model. Thus, 2 sub-systems have been developed:

a) Storey Plane Vectorization System

This system vectorizes the floor planes of each property and combines them into a storey plane. Multiple storey planes are then aligned and associated into a 3D model (refer to section 3 & Figure 8~9). The system is developed in Java Runtime Environment (JRE), which links to National Land Information Database via ODBC.

b) Basic 3D Cadastral Building System

This system provides an interactive user platform for allocating doors, windows, inner wall, columns, and textures, etc, into the 3D model. Detail location and size information are obtained from the construction plane (refer to Section 3 & Figure 10,14~15). The system is developed using Apache Tomcat, JRE, and Java 3D, etc.

2) Multipurpose Cadastral 3D Information System

This 3D web-based system is developed on SkylineGlobe. It adopts an N-Tier Distribution Computing design and uses browser as frontend. The backhaul contains a Web Server, an AP Server, a Map Server, and the National Land Information Database. The system is developed using JBoss, Java Development Kit (JDK) 1.5, Java, JavaScript, VBScript, and jQuery, etc. The system requires TerraExplorer Viewer, Java3D, and Hypercosm Player applications.

4.2 Data Exchange Framework

In order to exchange 3D cadastre data with other applications, this system uses CityGML semantics to implement the file exchange framework. Via Application Domain Extension (ADE) the respective CityGML features have been enriched with specific 3D cadastral attributes to meet the requirements of multipurpose cadastral 3D data exchange applications (Feng, 2009, Chiang&Feng. 2012)

In the framework developed, "3D Building" and "3D Storey" are subclasses of "_AbstractBuilding" defined in CityGML; "Roof", "Polygon", and "Wall" are subclasses of "_BoundarySurface"; "Door" and "Windows" are subclasses of "_Opening" and inherit all the attributes and behaviours. "Columns", "Stairs, Elevators" are subclasses of "IntBuildingInstallation". "Texture" is a "Datatype" class in association with "3D Building".

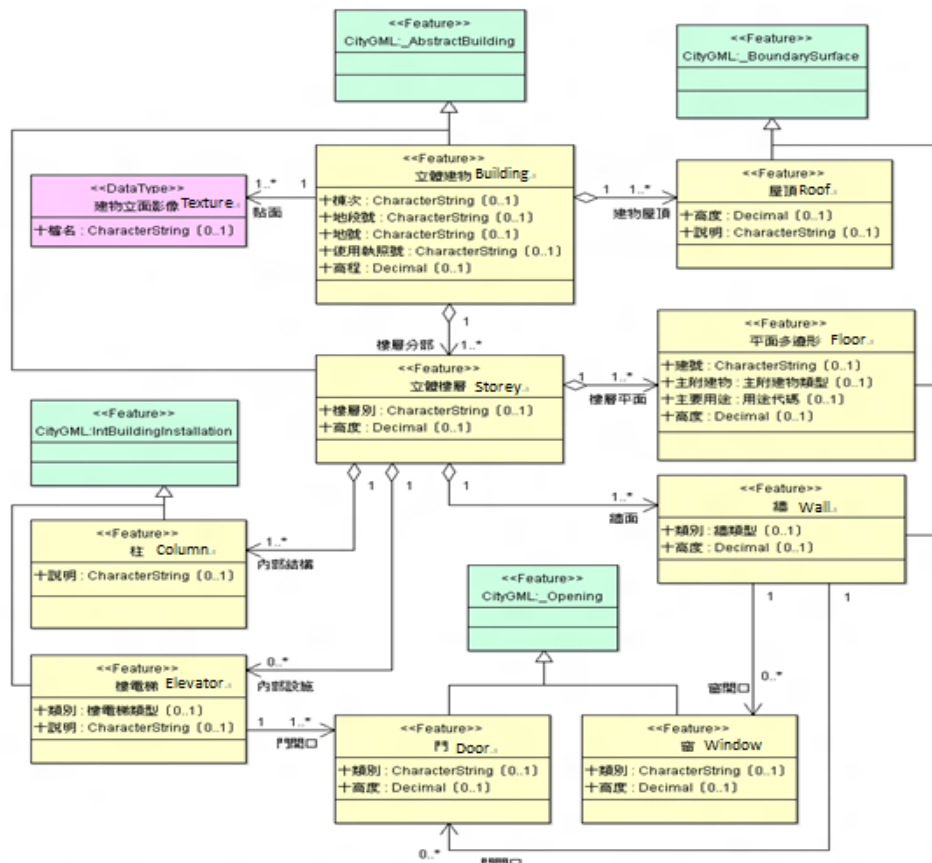

Figure 19. UML diagram of the Cadastral building 3D Application Scheme

4.3 3D Model Prototype System

The prototype system has been demonstrated in the 44th readjustment area in Gu-Shan District, Kaohsiung City. The area occupies approximately 144 hectares containing 1530 lots, 11310 registered building numbers, and approximately 550 buildings. The system utilizes zoning maps, topographic maps, orthophotomap, cadastre maps, digital terrain model, and the 3D cadastral building model developed to integrate with the land and building registration attributes of the National Land Information System (e.g. description, ownership, and other rights, etc) for system query and other applications.(Chiang, 2011)

The system is divided into 4 main function groups, including maps query, land service, development plan, and 3D application. The interactive query system uses conditions such as cadastre, address, or intersections, to display 3D results in one or more windows. Figure 20 shows the system browser view. Figure 21 shows the 2D system browser view. Figure 22 shows the query result of land location & building location. Figure 23 shows the query result of building ownership in the 3D space. Figure 24 shows the use of Hypercosm for interior decoration and navigation which may be applicable in rental applications. Figure 25 shows the building interior view. Figure 26 shows the editing of building ownership registration information. The overlay zone maps are shown in Figure 27.

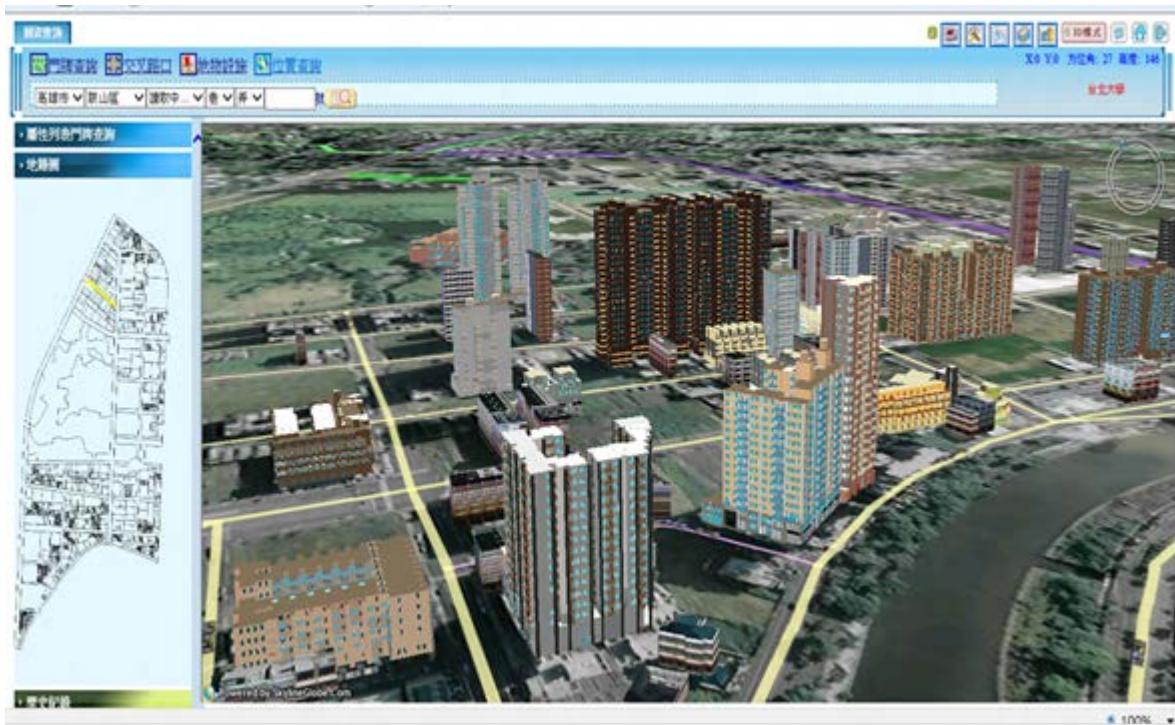

Figure 20. System browser view

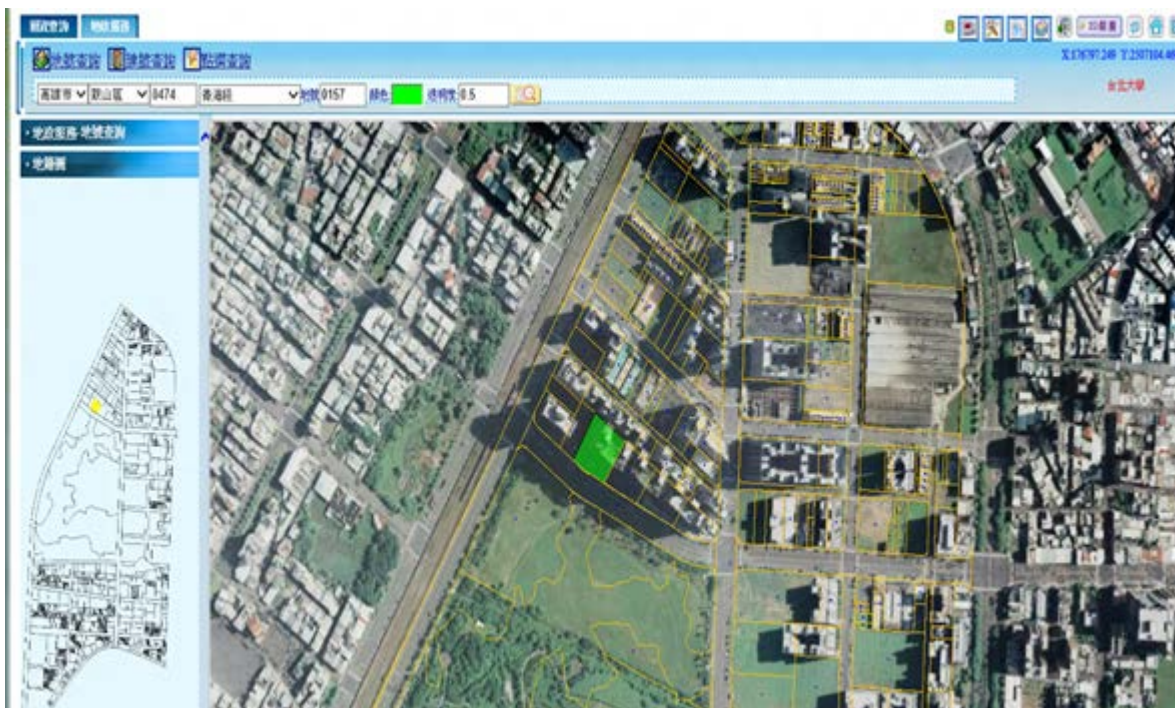

Figure 21. System 2D browser view (with cadastral map)

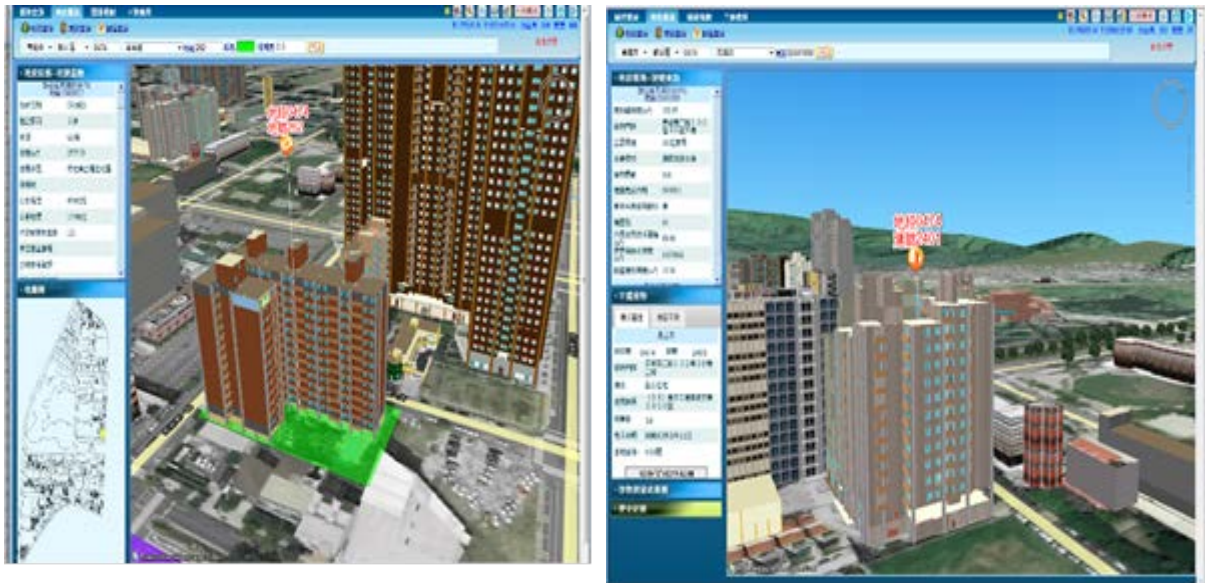

Figure 22. The land location & building information queries

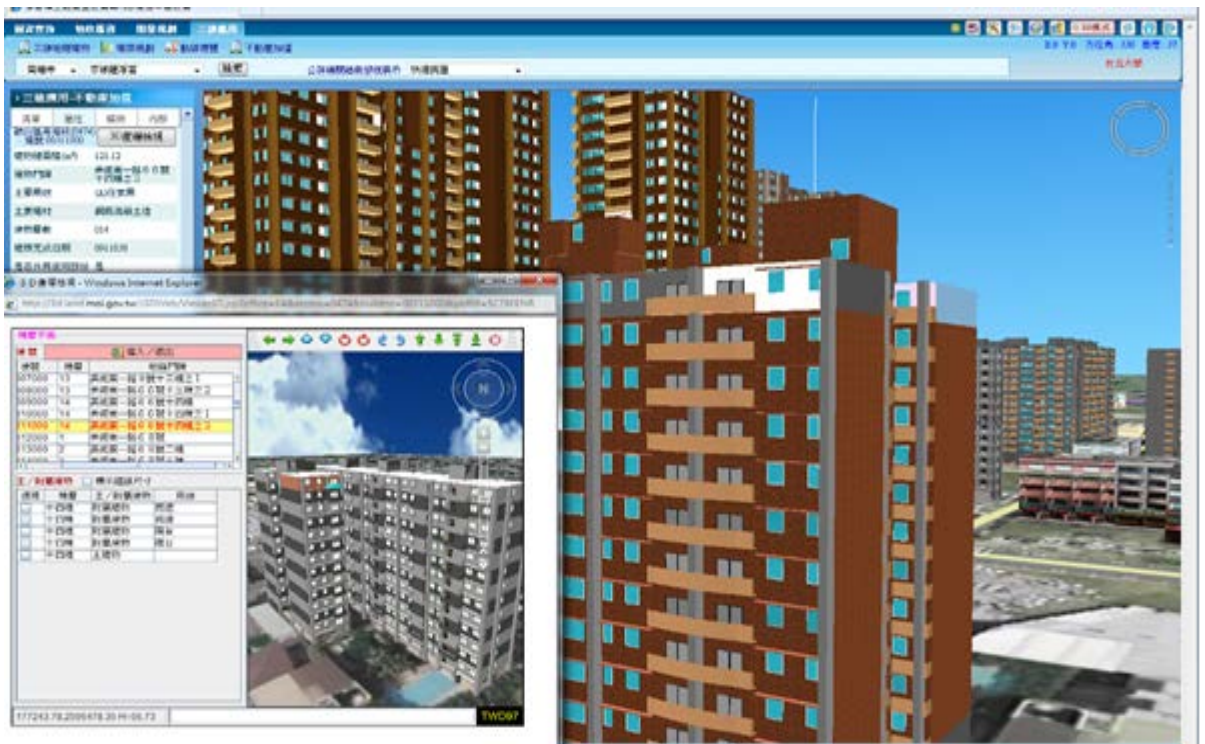

Figure 23. Property right location query with sub-window view



Figure 24. 3D building interior decoration and navigation with sub-window view



Figure 25. Building interior view

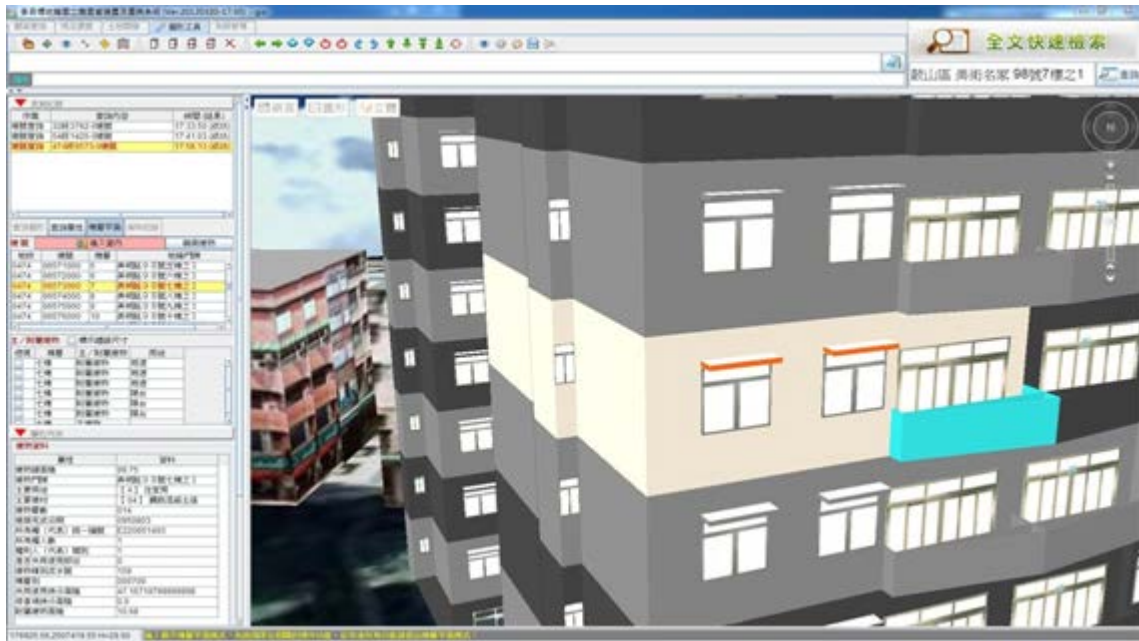

Figure 26. Editing of building ownership registration information



Figure 27. Overlay of the Zone map

5. CONCLUSIONS

This study describes the prototype system commissioned by the government. It demonstrates the use of result maps of building survey which kept by Land Offices to integrate floor planes in the same building to construct a 3D property model. Construction maps (kept for 15 years by local land offices) are further used to develop detailed 3D building models. Since the

building information contains building number, address, and building use license, it may be utilized in multipurpose applications such as real estate evaluation and rental, household management, school zone allocation, urban landscape, interior building browsing, and building security management, etc. The system is able to grant multiple levels of access right for privacy protection.

Although 3D registration has yet to be fully integrated into Taiwan's cadastral system, the current 5m DTM data and 1/1000 aerial photography maps (metropolitan area) armed with the 3D model proposed in this research can satisfy the demand for visualization and 3D property management. It can be expanded for further applications such as real estate evaluation, and building security management, etc. Although the BIM (Building Information Modelling) method is considered by various construction organizations, currently it is only utilized in large-scale public facilities. The linking with property registration is yet to be established. The 3D modelling strategy proposed in this research is feasible for both existing and future buildings. The scope of the 3D cadastral model is enormous. Based on the findings of this research, the National Economic Construction Committee is currently promoting more potential applications, a deployment strategy, and a relevant regulation amendment.

ACKNOWLEDGEMENTS

This research is sponsored by the Land Administration Department of the Ministry of the Interior and the Land Administration Bureau of Kaohsiung City Government.

The author would like to thank Director Mr. Shie Fu-Lai, and senior specialist Ms. Chen Hui-Ling, The Land Administration Bureau of Kaohsiung City Government, and system designer Mr. Chang Perng-Shiou, the Land Administration Department of the Ministry of the Interior, for their advice and support of the plan execution. Special thanks to the research team colleagues for their hard efforts over the years.

The author is grateful to the anonymous reviewers for their valuable comments.

REFERENCES

Abdul Rahman, Alias; Hua, Teng Chee; Van Oosterom, Peter (2011). The Netherlands Embedding 3D into Multipurpose Cadastre, FIG Working Week 2011, Marrakech, Morocco, 18-22 May 2011.

Aien, Ali; Rajabifard, Abbas; Kalantari, Mohsen; Williamson, Ian (2011). Aspects of 3D Cadastre - A Case Study in Victoria, Australia, FIG Working Week 2011, TS02G - 3D Cadastre and Case Studies.

Chang, Yi-Hsiung (2010). Study on Building Information Model Based on Cadastre Data, National Taipei University Dept. of Real Estate & Build Environment Master paper. (in Chinese)

Chiang, Hun-chin (2000). Planning and design of Building surveying system. In: The 19th

Conference on Surveying and GeoInformatics, Taiwan. (in Chinese)

Chiang, Hun-chin (2009a). Multipurpose 3D Cadastre Building Systems, Final report, Land Administration Bureau, Kaohsiung City Government. (in Chinese)

Chiang, Hun-chin (2009b). 3D Building Modeling and Applications Based on Floor Plans of Buildings. In: Journal of Taiwan Land Research, vol.12, No.1, P31~53. (in Chinese)

Chiang, Hun-chin (2011). Multipurpose Cadastre 3D Mapping Systems, Final report. Ministry of the Interior Project. (in Chinese)

Chiang, Hun-chin and Feng, Yi-Chieh (2012). Establishment of Data Exchange Framework for 3D Cadastral Building Model. In: Journal of Taiwan Land Research, vol.15, No.1, P127~155. (in Chinese)

Li Deren, Zhu Qing, Liu Qiang, Xu Peng (2005). From 2D to 3D GIS for CYBERCITY, Geospatial Information Science , vol. 7, no. 1, pp. 1-5, 2004

Döllner, J. and Buchholz, H. (2005). Continuous level-of-detail modelling of buildings in 3D city models. In: Proc. of the 13th ACM International Symposium of Geographical Information Systems, ACM GIS 2005, 173-181.

Feng, Yi-Chieh (2009). Establishment of Data Exchange Framework for Multi-Level 3D Cadastre Building Model, National Taipei University, Dept. of Real Estate & Build Environment Master paper. (in Chinese)

Frédéricque, Benoit; Raymond, Keith and Van Prooijen, Kees (2011). 3D GIS as Applied to Cadastre—A Benchmark of Today's Capabilities, FIG Working Week 2011, TS01C-3D Cadastre and 3D Information.

Gröger, G., Kolbe, T. H., Czerwinski, A. and Nagel, C. (2008). City Geography Markup Language (CityGML). OGC Encoding Standard, Version 1.0.0, OGC Doc. No. 08-007r1, Open Geospatial Consortium .

Reida Elwannas(2011), 3D GIS: It's a Brave new World, FIG Working Week 2011, TS01C - 3D Cadastre and 3D Information

Van Oosterom, Peter; Stoter, Jantien; Ploeger, Hendrik; Thompson, Rod and Karki, Sudarshan (2011). World-wide Inventory of the Status of 3D Cadastres in 2010 and Expectations for 2014, FIG Working Week 2011, TS01C - 3D Cadastre and 3D Information (4968).

BIOGRAPHICAL NOTES

Hun-Chin Chiang is an Associate Professor in Dept. of Real Estate and Built Environment, National Taipei University. He has pursued teaching in geographic information and land cadastral surveying for over 30 years. He has assisted government agencies in developing building surveying information systems, digital cadastral management systems, and the real estate database of Taipei City, etc. He is currently assisting Taiwan government to conduct 3D cadastre research.

CONTACTS

Hun-Chin Chiang
Dept. of Real Estate and Built Environment, National Taipei University,
No. 151, University Rd., San Shia, New Taipei City, Taiwan
Tel.: 886 2 86741111ext.67420
Fax: 886 2 86715308
E-mail: vincent@mail.ntpu.edu.tw

