

3D Modelling for Multipurpose Cadastre

Alias ABDUL RAHMAN (Malaysia), Peter VAN OOSTEROM, The Netherlands,
Teng CHEE HUA, Khairul Hafiz SHARKAWI, Edward Eric DUNCAN,
Norsuhaibah AZRI and Muhammad Imzan HASSAN, Malaysia

Key words: Multipurpose Cadastre, 3D modelling, LADM

SUMMARY

Three-dimensional (3D) modelling of cadastral objects (such as legal spaces around buildings, around utility networks and other spaces) is one of the important aspects for a multipurpose cadastre (MPC). This paper describes the 3D modelling of the objects for MPC and its usage to the knowledge of 3D cadastre since more and more related agencies attempt to develop or embed 3D components into the MPC. We also intend to describe the initiative by Malaysian national mapping and cadastral agency (NMCA) in developing the 3D MPC. In this case, we strongly believe that 3D city modelling approach could be utilized for such purposes, e.g. linking the physical and legal spaces of buildings and other objects within the multipurpose cadastre as well as for developing the relevant database, thus, provide queries to the objects. Other relevant information and services also could be developed for other layers within MPC for different applications or services. Basically, the Malaysian MPC consists of large scale spatial data layers grouped into two types of sub systems. The first group consists of components with spatial objects to which legal and administrative facts are attached (rights, restrictions and responsibilities), such as 3D cadastre (volume parcels), 3D marine cadastre, and 3D strata (in buildings). The second group consists of components with reference to physical spatial objects, such as: 3D topography (with buildings footprints), underground utility (3D), and 3D city model (with roof structure and LoD3 buildings) where each of these components will be elaborated and discussed in this paper. As one of the components for the proposed Malaysian MPC, 3D models of cadastral objects are needed to support the existing cadastre system by providing spatial and semantic information of the 3D objects according to the exact situation as in the real world. The representation of the real world objects in 3D form will enable the concerned parties to understand the situation and problems related to the particular land site as well as increasing the efficiency in managing land-related matters. The concept for 3D volume parcels for 3D cadaster and 3D modelling with underground utility networks is presented. This paper relates the Malaysian MPC model with the LADM (Land Administration Domain Model) where the generation of the UML model that complies with the concept of LADM for the Malaysian MPC is addressed. We anticipate that the proposed approach for the MPC could be implemented by the authority in the near future. Outlook for future works and the emerging 3D modelling technologies for the MPC then form a part of conclusions of this paper.

3D Modelling for Multipurpose Cadastre

Alias ABDUL RAHMAN (Malaysia), Peter VAN OOSTEROM, The Netherlands
Teng CHEE HUA, Khairul Hafiz SHARKAWI, Edward Eric DUNCAN,
Norsuhaibah AZRI and M. Imzan HASSAN, Malaysia

1. INTRODUCTION

Three dimensional (3D) modelling of cadastral objects such as legal spaces of and around buildings, utility networks and other spaces is one of the future aspects for the Malaysian multipurpose cadastre (MPC). 3D modelling of objects for MPC will provide the know how to develop and embed the 3D component into MPC. Malaysian MPC consists of large scale spatial data layers grouped into two types of subsystems. The first group consists of components with spatial objects to which legal and administrative facts are attached (rights, restrictions and responsibilities), such as 3D cadastre (volume parcels, 3D marine cadastre and 3D strata (in buildings)). The second group consists of components with reference to physical spatial objects, such as: 3D topography (with building footprints), underground utility and 3D city model (with roof structure and LoD3 buildings). The cadastre also serves as the supporting tool for land policies, fiscal policies and agricultural policies. Current European multipurpose cadastral systems are intended for either taxation or for title registration for planning purposes. Common denominators in these types of cadastre are the unambiguous identification of spatial property and a standardised numbering scheme that is uniformly referenced. This identification method allows different vertical application areas, such as taxation, legal, and planning offices, to refer to the same real property. Thus, when the fiscal cadastre promulgates a change on the tax record of a specific parcel, a GIS map shows the tax information changes on the same parcel for the legal cadastre.

The cadastral registration system in Malaysia is a parcel based system and it is 2D in nature (Abdul Rahman et al., 2011). Currently 2D cadastre mapping is practiced in Malaysia which provides vital land and property information like ownerships of the parcels for most parts of the country. This system of cadastral information has served most of the users need for decades. However, in the very near future, 2D information may no longer be able to serve the community, especially in more complex situations such as buildings above roads in some large cities and towns such as Kuala Lumpur in Malaysia as shown in Figure 1.



Figure 1. Complex cadastral situations in Kuala Lumpur

One way to deal with this situation is by having a more advanced cadastral system like multipurpose cadastre (MPC). This means we need to extend the 2D cadastre system into a system that is able to deal with various aspects of cadastre such as 3D cadastre (Stoter, 2004), 3D marine cadastre, and 3D city models (Abdul-Rahman et al. 2005). There are several drawbacks from the existing cadastre system such as building footprints are hardly available within cadastre parcels, strata information is hardly linked to the stratum, real 3D buildings with proper and real textures are not available within the parcel lots and obviously the associated database. A new version of cadastre, i.e. the MPC could provide the relevant information to various agencies and individuals in the country. Feature objects such as buildings on land parcels can also change with time since new developments, constructions and renovations occur in most cities thereby affecting the 3D cadastral objects, namely the 3D building models. These changes need to be mapped and documented in order to ensure that the information is relevant for future analysis, thus, signalling the importance and needs for automation in the 3D cadastral objects updating process based on an embedded change detection in relation to geometric and semantic techniques. The Malaysian MPC model should be within the frame work of the LADM (Land Administration Domain Model) where the generation of the UML model that complies with the concept of LADM for the Malaysian MPC can be indicated and addressed. Section 2 describes 3D spatial and semantic information within the MPC in relation to cadastre, marine cadastre and underground utility.

2. 3D SPATIAL AND THEMATIC SEMANTIC INFORMATION

3D spatial and semantic information for 3D cadastre requires accurate data collection methods and this introduces complexities as to which data is relevant at which specific time. Spatial data will hold information such as the unique parcel identifier, the area and the geometry of the land parcel with the data of the footprints of the building within the parcel being the ownership number, floor area and the geometry of the building (Hassan and Abdul Rahman, 2011). Semantic information will hold information such as the owner identity or number, owner name, parcel history, number of floors, floor height, volume space, type of lease etc. Semantic information in this regard has to be rich to give all the necessary details about the land parcel. In 3D modelling implicit or explicit geometry could be used to generate the 3D model. The integration of Building Information Models (BIM) can also help in the data collection process for 3D cadastre, but this can be carried out if the integration of CityGML and IFC standards can be achieved. The spatial unit package defines spatial units as being 2D (land) or 3D (space) spatial units, buildings and utility networks. These include topological spatial units, polygon spatial units, line spatial units, point spatial units and text spatial units (ISO19152, 2012).

2.1 Cadastre

At the centre of any land administration system is the cadastre which exhibits or shows the record of all the interests associated with the land, this is described as the rights, restrictions and responsibilities (RRR) associated with the land. The cadastre usually will include the geometric dimensions of the parcel, the interest, ownership and value among other attributes of the land. It is said nobody has absolute ownership of land but rather own rights to the said

land according or in relation to local laws, practices and encumbrances. Hassan and Abdul Rahman (2010) introduced the framework for the Malaysian MPC, here further details of the attributes are presented.

2.2 Marine Cadastre

The current principle on cadastre is geared towards addressing land and extents to the High Water Marks (HWM) for countries sharing boundaries with water bodies such as the ocean. The marine environment introduces complexities that are not inherent in land based spatial data. The marine space involves rights and responsibilities that are time based. However often land is being introduced as being in relation to the earth surface which invariably includes the land and sea surface, however an integrated administrative structure will have to be promulgated to administer and exhaust all the range of rights, restrictions and responsibilities for the land and marine environments. Hence a marine cadastre system can then record all the complexities associated with the determination of the spatial extents, rights, interests, property rights, restrictions and responsibilities within the marine jurisdiction.

Marine cadastre is currently new in Malaysia despite the fact that it is a maritime country. The marine environment in Malaysia consists of activities such as sea navigation, fishing, tourism, oil and gas. The complexities of this environment are yet to be realised in Malaysia. The United Nations Convention of the Law of the Sea (UNCLOS) (UN, 1983) has established various jurisdictions, under which a country can administer, manage and utilize its maritime environment. Malaysia in conformity with UNCLOS has also enumerated some acts to further enhance its territorial boundaries such as the 1969 ordinance under Article 150(2), No 7 among others stated that the territorial waters of Malaysia (except in the Straits of Malacca, the Sulu Sea and the Celebes Sea) were declared as 12 nautical miles from the base line determined in accordance with UNCLOS. The Continental Shelf Act of 1996 (Act 83) declared the territorial waters and continental shelf limits, the Fisheries Act, Marine Parks Malaysia Order of 1994 was aimed at protecting the Marine Park. Nichols et al. (2000) described the various rights for the marine cadastre as, public access, navigation, fishing, airspace, seabed use, development, mineral, water column and riparian (see Figure 2).

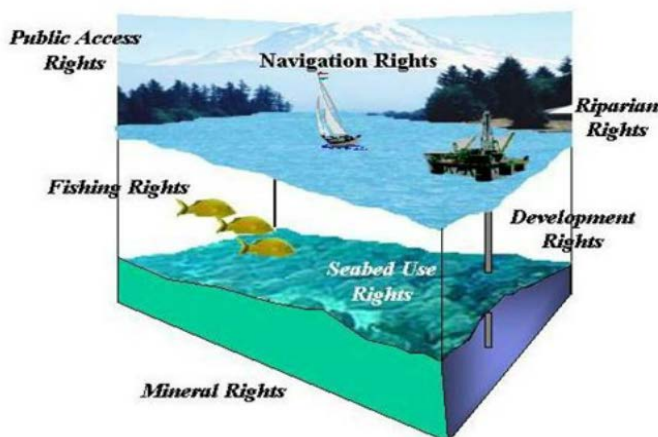

Figure 2. Rights for marine cadastre (Nichols et al., 2000)

Marine objects can be described as sea surface objects, water volume objects, seabed objects, and sub seabed objects. These can be demarcated up to a country's Exclusive Economic Zone (EEZ). The rights for marine cadastre are overlapping in nature which makes the demarcation of marine parcels or lots a complex issue. The management, exploration and exploitation of marine resources are usually for the benefit of the country and stakeholders up to its EEZ. Marine parcels or lots can be integrated with the current LADM to make them compatible with the marine environment.

2.3 Underground utility

3D underground utility themes have been identified as one of the important layers that requires to be integrated in a cadastre database (Abdul Rahman et al., 2011). A central utility database will enhance knowledge about underground utilities (Chong, 2006; He et al., 2002; Penninga and van Oosterom, 2006). Such a database will create knowledge about the location and exact utility rights that need to be promulgated, this will serve as a basis for the city authority to establish exact locations for the various utility networks in a city. Three main problems have been identified by Abdul Rahman et al. (2011):

- Cadastre databases are not integrated with underground databases and other databases such as taxation, insurance etc.
- Softwares (eg. GIS, CAD, AM/FM) available are currently in 2D.
- Visualization of utility networks is difficult to interpret due to the 2D maps and inadequate information on height (Z).

Currently underground utility networks are developed in 2D thereby creating several difficulties in terms of height, type, width and colour on a 2D plan. 2D plans are inaccurate in terms of location and other overlay difficulties on a 2D plan. Hence the 2D plans cannot indicate real world events, the 3D situation can represent real world and a more accurate location when it comes to underground utility. Thus, underground pipelines can be handled in a more efficient way in a 3D environment. But the problem to handle pipelines in 3D is unsupported or lacks geometry type in a spatial database. A spatial database offers several basic 3D geometry types but not all 3D geometries are available, volumetric shapes and complex objects are difficult to achieve. Figure 3 shows underground 3D pipelines within a city model environment. More efforts are required to fully integrate underground utility networks into the Malaysian MPC.

The Department Survey and Mapping, Malaysia (DSMM) has the ultimate responsibility of maintaining the database of all underground utility data in Malaysia (Abdul Rahman et al., 2011). To ensure this the National Underground Utility Database has been created, research, in collaboration with the Universiti Teknologi Malaysia (UTM) is on going, and the integration of the underground utility networks with current 3D city models being explored. Initial results are shown in Figure 3. Section 3 will discuss the 3D modelling approach for MPC, UML diagrams of required details for the MPC and a concept for 3D volume parcels is presented.



Figure 3. (a) 3D utility network with buildings, plants and street furniture and (b) surface and subsurface 3D objects with utility network

3. 3D MODELLING APPROACH

3D modelling involves the usage of 2D maps or digital photogrammetric maps which displays cadastre parcels or lots. Footprints of buildings or other features within a specific parcel are then either extruded or using implicit geometry to create the appropriate wireframe from which the facades of such buildings can be created and textured to give such buildings a level of realism. In this research the 3D TIN is used to generate the basic cube using a tetrahedral mesh which can be used to represent volume parcels for buildings or any other feature on a parcel of land. Using model generation for 3D GIS property data can be represented for features above and below the land parcel to determine a more accurate geometry for 3D volume parcels or spaces. The UML concept for the creation of a prototype cadastre model within the LA-Spatial Unit of the LADM is presented. The parcel identification (ID) in Figure 5 for the features on surface is linked to parcel ID's for the strata and stratum for the Malaysian 3D cadastre. The above surface object identifies buildings, complex buildings such as mosques and city landmarks, city furniture and utility networks. Below surface classes consider man-made constructions, utility, rock type and geology for the subsurface. Figures 4, 5 and 6 show a specific parcel with above, on and below attributes.

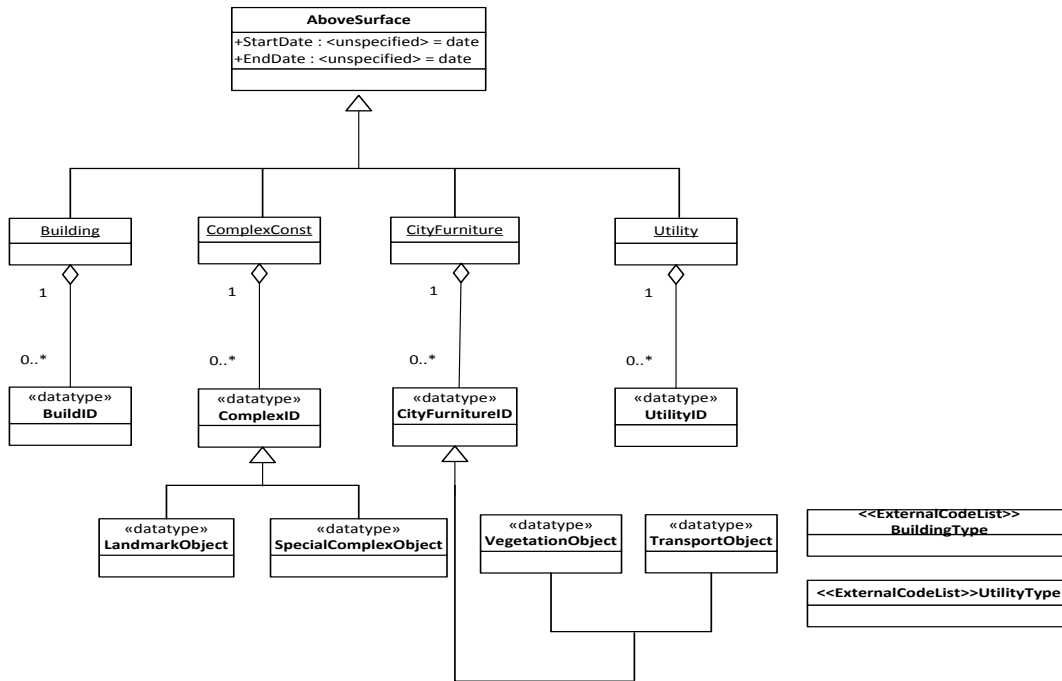

Figure 4. The Above Surface features and data types

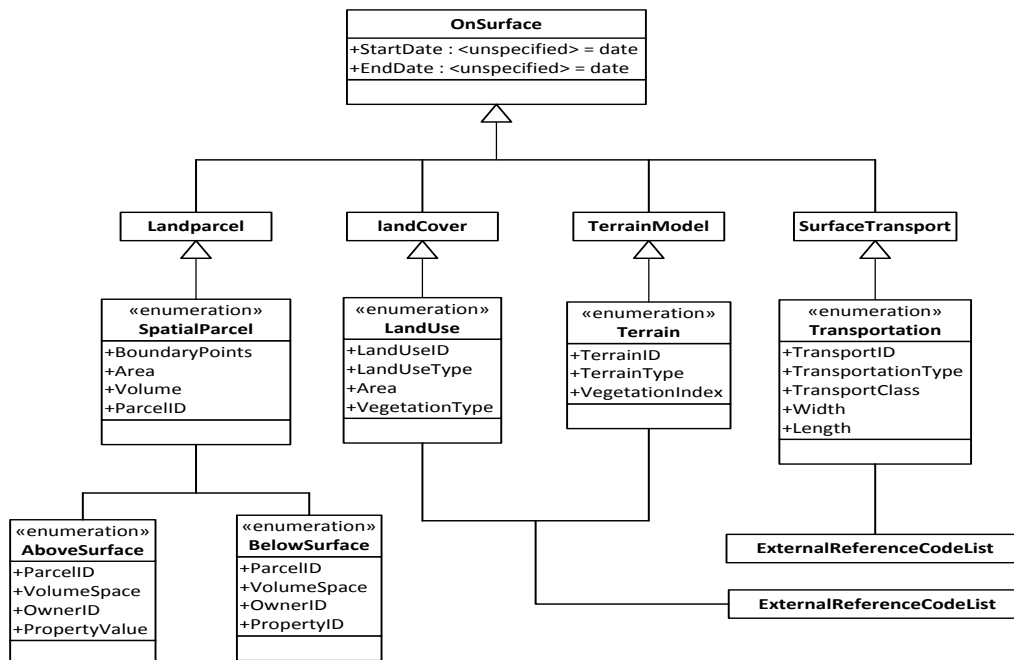

Figure 5. On Surface classes and data enumerations

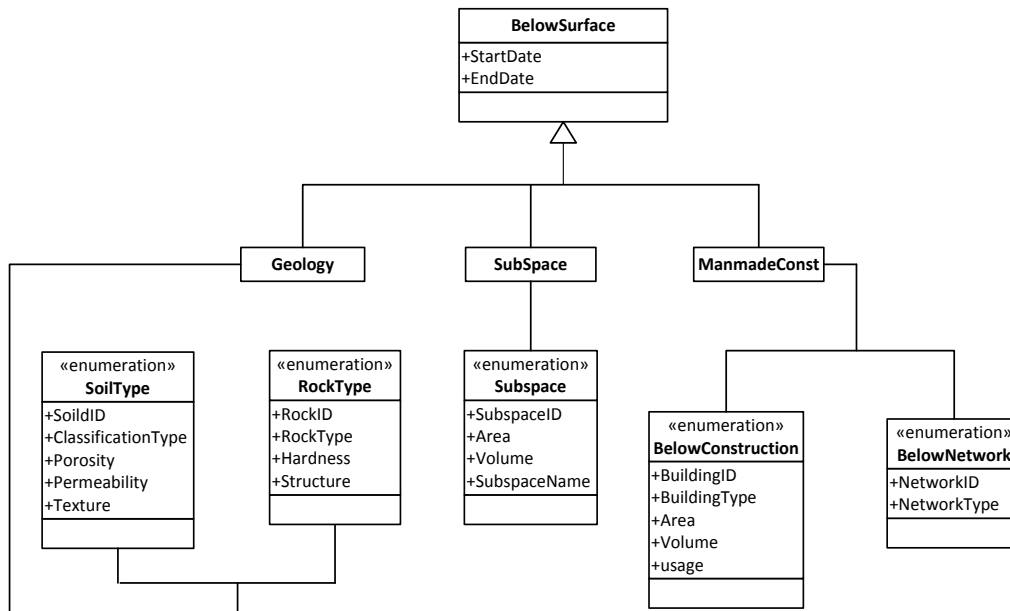

Figure 6. Below Surface classes and data enumerations

The unification of the surface parcel with its above and below parcels is shown in Figure 5. The identification and naming of such unique parcels for Malaysia has been discussed by Hassan and Abdul Rahman (2010). The concept for representing volume parcels in 3D for land parcels for the 3D cadastre is also represented in Figure 7.

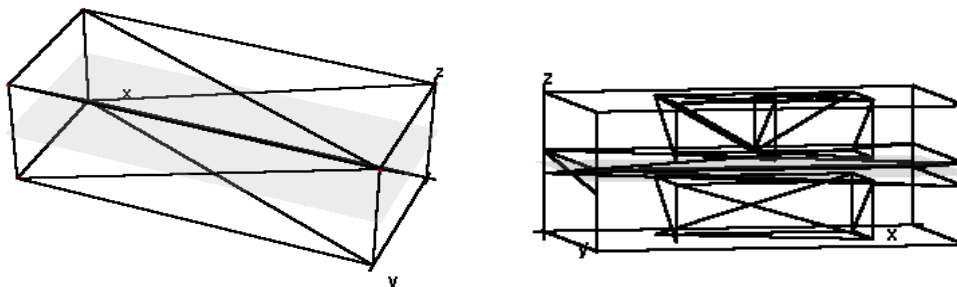

Figure 7. Wireframe generated from 3D TIN for unified volume parcels

Section 4 introduces the LADM, indicates areas for the integration of the Malaysian MPC, and discusses indications for the marine cadaster. The benefits for the Malaysian MPC are highlighted.

4. LADM AND 3D CADASTRE ALTERNATIVES FOR THE MALAYSIAN MPC

In the previous sections the different types of cadastral objects in the Malaysian cadastre have been explained, including marine cadastre and underground utilities. Also the 3D modelling has been explained. This section explains how this fits within the ISO FDIS 19152 Land Administration Domain Model (ISO/TC211, 2012; Lemmen et al., 2010): “The LADM is a

conceptual model, and not a data product specification ... The purpose of the LADM is not to replace existing systems, but rather to provide a formal language for describing them, so that their similarities and differences can be better understood. This is a descriptive standard, not a prescriptive standard. Land administration is a large field; the focus of this International Standard is on that part of land administration that is interested in rights, responsibilities and restrictions affecting land (or water), and the geometrical (geospatial) components thereof. The LADM provides a reference model...". The LADM is under development within the Technical Committee 211 (TC211) of the International Organisation for Standardization (ISO) and identified as ISO 19152.

Based on the LADM (a conceptual model), a more refined country profile should be developed: selecting the relevant classes from LADM and adding country specific attributes, associations or even classes. The LADM covers both the spatial aspects (main class LA_SpatialUnit) and the non-spatial aspects of land administration (main classes LA_Party, LA_RRR, and LA_BAUnit); see Figure 8. In this paper we focus on the spatial part of the model and less on the legal/admin parts of the model. The main reason to apply the LADM is to reuse the collective knowledge from many countries in land administration and to have unambiguous definitions of the key concepts. For the Malaysian country profile, the integrated support for both 2D and 3D parcels is very useful. Also, the specialization of LA_SpatialUnit with the subclass LA_LegalSpaceUtilityNetwork is very appropriate. Therefore the 2D/3D spatial representation aspects of the LADM are further discussed in this section. For 3D marine objects there is not yet an existing generic class in the LADM, so this has to be added in the country profile. It should be noted that this is not a Malaysian specific situation and marine objects are (or will become) relevant in many countries (Ng'ang'a et al., 2001). The marine cadastre objects have a true 3D nature and therefore really need 3D cadastre support. One could even argue that tight integration with time (not via separate temporal attributes, but via 4D spatio-temporal primitives) would be useful (Döner et al., 2010). However, at the moment there are no (GIS or spatial DBMS) systems that support 4D primitives and also the LADM does not support this. For the time being, the modelling of these objects is based on separate 3D spatial description and additional temporal objects.

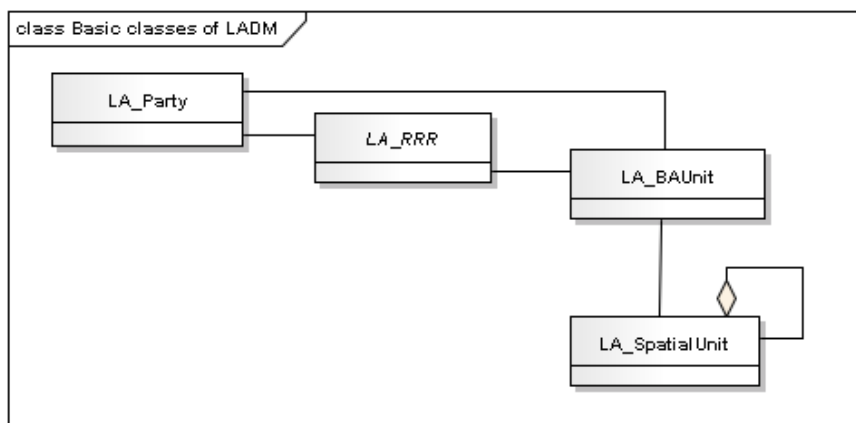

Figure 8. The 4 basic classes of the LADM (from ISO/TC211, 2012)

The term ‘3D cadastre’ can be interpreted in many ways ranging from a full 3D cadastre supporting volume parcels, to traditional cadastres in which limited information is maintained on 3D situations. In our previous research (Stoter and van Oosterom, 2005; 2006) we distinguish different conceptual models for a 3D cadastre, which are all included in the LADM.

Within the LADM classical cadastral concepts as “parcel” and “boundary” have been extended to include spatial representations of overlapping tenures or claims and also multidimensional objects: 3D and 2D/3D, combined with temporal dimensions (Lemmen et al., 2010). Text based, sketch based, point based, line-based, polygon based, or topological based representations of spatial units (parcels) are possible. Spatial units may have a 3D representation, and a provision is made for a mixture of 2D and 3D spatial units to co-exist (such as 3D parcels as explained in subsection 2.1). A level is a collection of spatial units with a geometric or thematic coherence. The concept of level is related to the notion of “legal independence” from ‘Cadastre 2014’ (Kaufmann and Steudler, 1998). This allows for the flexible introduction of spatial data from different sources and accuracies, including utility networks (as described in subsection 2.3), buildings and other 3D spatial units, such as marine objects (as described in subsection 2.2), mining claims, or construction works. New legal topics can simply be added by including a further (information) level. In this way it is also possible to deal with facts which are not formally written down in a law, supporting the continuum of rights (GLTN, 2006; UN-HABITAT, 2008). A similar ‘continuum’ principle can be applied to the development of a range of spatial units in relation to the quality of spatial representation: from text to full 3D spatial representations. The main class of the spatial units package of LADM is class LA_SpatialUnit (with LA_Parcel as alias). Spatial units are refined into two specializations, which both have quite often a 3D spatial representation (see Figure 9): 1. building units (in class LA_LegalSpaceBuildingUnit), and 2. utility networks (in class LA_LegalSpaceUtilityNetwork).

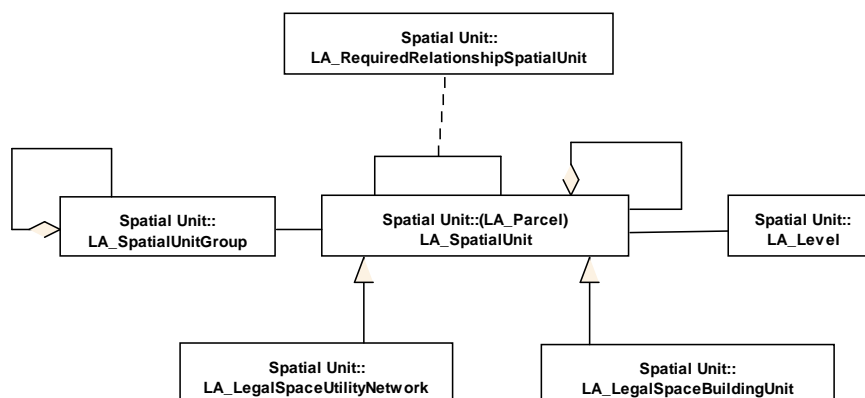

Figure 9. Classes of Spatial Unit Package and associations between them (from ISO/TC211, 2012)

The ‘Spatial Representation and Survey’ subpackage of LADM allows a large number of possible representations of spatial units in 2D, 3D, or mixed (integrated 2D and 3D). All types of LA_SpatialUnit (2D, 3D parcels, buildings, or utility networks) share the same representation structure (Lemmen et al., 2009). An important requirement is that existing 2D

data should be easily included. At the same time, the model must support the increasing use of 3D representations of LA_SpatialUnit, without putting additional burden on the simpler 2D representations. There should be no mismatch between the parts of the domain that are described in 2D and the parts of the domain that are described in 3D. The LADM has been designed using key concepts such as LA_BoundaryFaceString and LA_BoundaryFace. Coordinates themselves are rooted in instances of LA_SourcePoint (mostly after georeferencing, depending on the data collection method used).

As pointed out by (Stoter, 2004), in many countries a 2D description should be interpreted as a 3D prismatic volume with no upper and lower bound (see Figure 10; upper left and upper right). Using this interpretation, 2D and 3D representations can be unified. The boundaries in the 2D descriptions are called LA_BoundaryFaceString: they use a normal 2D line string for storage, but this implies a series of vertical faces. For true 3D descriptions that also have nonvertical faces, the class LA_BoundaryFace is introduced. A liminal spatial unit has a combination of LA_BoundaryFaceString's and vertical LA_BoundaryFace's. The vertical LA_BoundaryFace's must dissolve into face strings (when common pairs of edges are removed). The faces must be completely defined from $+\infty$ to $-\infty$. This method is used for a 2D spatial unit which is adjacent to a 3D spatial unit, with a split in the shared vertical face. The attribute 'type' in LA_SpatialUnit indicates if it concerns a 2D, liminal or 3D representation of an LA_SpatialUnit. It must be stressed that the above applies to any type of LA_SpatialUnit (including the ones that are used for recorded spaces around buildings and utilities, or for servitudes).

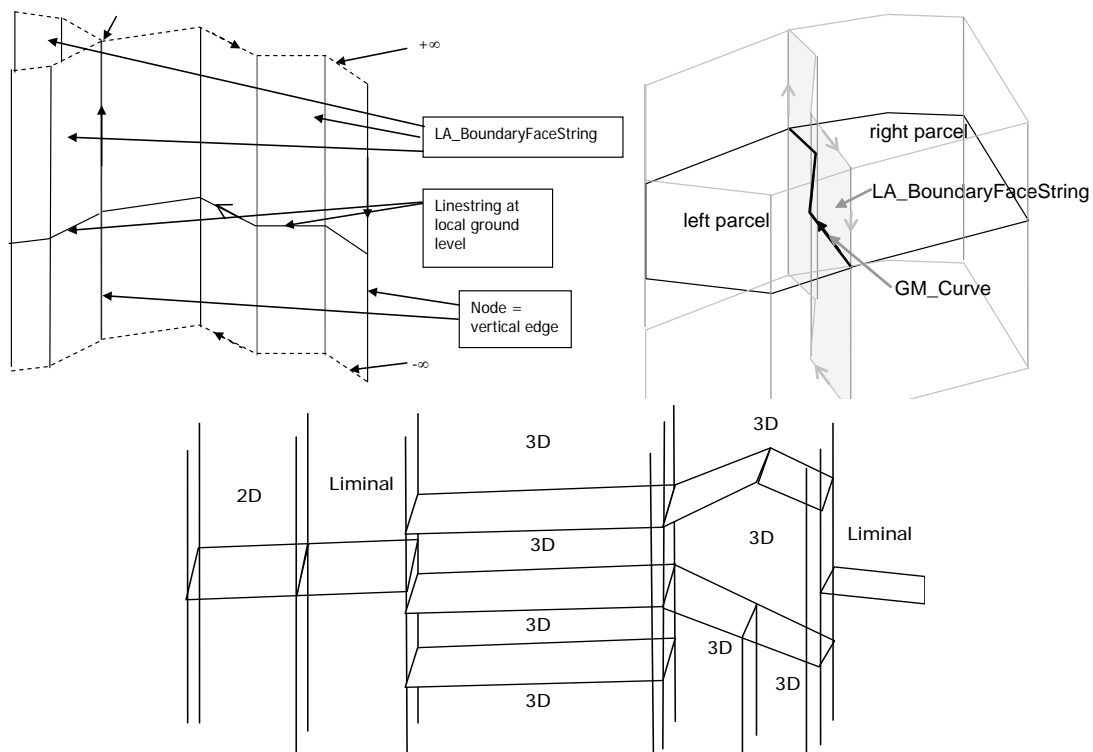

Figure 10. Top: Boundary face string concepts; Bottom: Side view showing the mixed use of boundary face strings and boundary faces to define both bounded and unbounded 3D volumes (from ISO/TC211, 2012)

To organise the instances, the LADM has the level model. For example, there can be a base level with ownership LA_SpatialUnit's, which are topologically defined and there could be an additional level with polygon based LA_SpatialUnit's representing servitudes. The concept of levels can be used very well in 3D situations; e.g. level 1 containing ownership (2D, liminal and 3D topological LA_SpatialUnit's) and level 2 would contain ownership of 'legal space' around utilities crossing many other LA_SpatialUnit's (from which the utility network space could be subtracted); see Figure 11.

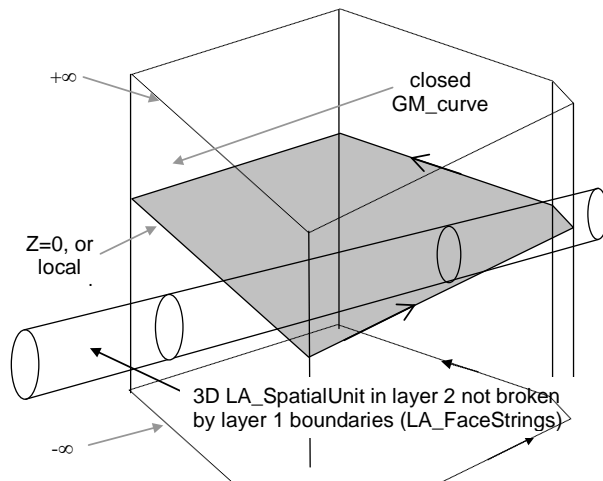

Figure 11. Multiple levels (note that the ellipses where the level 1 boundaries meet the 3D LA_SpatialUnit in level 2 are there for visualization support and do not subdivide the object in level 2) (from ISO/TC211, 2012)

In the LADM, 2D and 3D data are treated in a consistent manner throughout the model. It is important to realise that there is a difference between the 3D physical object itself and the legal space related to this object. The LADM only covers the 'legal space'; that is the space that is relevant for the land administration (bounding envelope of the object). This is usually larger than the physical extent of the object itself (for example including a safety zone). To be able to register the (2D or 3D) parcels in the cadastral registration, all real estate objects must have a survey document (LA_SpatialSource), which should make clear to what space the real estate object refers.

4.1 Benefits of the Malaysian MPC

A well-structured MPC will be of benefit to the government, public agencies, private firms, regional bodies, academia and individuals. The MPC will serve as the land information bank of Malaysia which will contain all available spatial and semantic information concerning land parcels. Visualization of these parcels in 3D, i.e. volume parcels, will further enhance the MPC and introduce the concept of 3D modelling. As an integrated land information system it can exhibit data on ownership, rights and all encumbrances associated with the land parcel. This promotes transparency and wealth creation in the land market. Inventory of all land parcels together with information for the strata and stratum will strengthen property ownership, project implementation and monitoring. Agencies can identify areas for planning

and further development. The tax system of Malaysia can be more efficient and dealings with banks and insurance companies made more transparent. The proposed National Underground Utility Database for Malaysia when incorporated in the MPC will streamline the provision of essential services such as electricity, water, sewerage, and communication networks. The management of the public utility networks will be more efficiently managed. Other indirect benefits of the MPC can include crime prevention, population control, census mapping, location and management of educational centres.

5. CONCLUSIONS AND FUTURE WORKS

3D modelling for 3D cadastre has been initiated and a concept for volume parcels introduced. The multi-purpose cadastre (MPC) must be integrated to include marine parcels and the strata and stratum condition unified. The incorporation of the National Underground Utility Database with 3D city modelling for the Malaysian MPC is on-going and initial results presented. The Malaysian MPC model is compatible with the LADM (Land Administration Domain Model). That the UML details of the model comply with the concept of the LA_SpatialUnit of the LADM for the MPC has been presented. The benefits to be derived from the MPC with the incorporation of 3D modelling and underground utilities have been enumerated. We anticipate that the proposed approach for incorporating 3D modelling could be implemented for the MPC by the authorities in the near future.

ACKNOWLEDGEMENTS

The authors will like to appreciate the support of the 3D GIS research group of the Faculty of Geoinformation and Real Estate of the Universiti Teknologi Malaysia (UTM) and the Research Management Centre (RMC) of UTM. The research of Peter van Oosterom is supported by the Dutch Technology Foundation STW, which is part of the Netherlands Organisation for Scientific Research (NWO) and partly funded by the Ministry of Economic Affairs, Agriculture and Innovation (Project codes: 11300 and 11185).

REFERENCES

- Abdul Rahman, A., Hua, T. H. and van Oosterom, P. (2011). Embedding 3D into Multipurpose Cadaster. FIG working week, Marakech, 18-22 May, 2011.
- Abdul-Rahman, A., Stoter, J. E. and Nordin, A. F. (2005). Towards 3D Cadaster in Malaysia. International Symposium and Exhibition on Geoinformation (ISG 2005). Penang, Malaysia., pp. 10.
- Breunig, M., Cremers, A., Muller, W. and Siebeck, J. (2001). New Methods for Topological Clustering and Spatial Access in Object-oriented 3D databases. In: Proc. of the 9th ACM Int. Symp. On Advances in Geographic Information Systems.
- Chong, C. S. (2006). Toward a 3D Cadastre in Malaysia – An Implementation Evaluation. Delft, Delft University of Technology: 110.

Döner, R., Thompson, R., Stoter, J., Lemmen, Ch., Ploeger, H., van Oosterom, P. and Zlatanova, S. (2010). 4D cadastres: First analysis of Legal, organizational, and technical impact - With a case study on utility networks. In: Land Use Policy, Volume 27, pp. 1068-1081.

GLTN (2006). Global Land Tool Network (GLTN). Themes and issues. Nairobi, Kenya, UN-HABITAT United Nations Human Settlements Programme: 29 p. Online available via http://www.gltm.net/images/Downloads/gltm_themes.pdf

Hassan, M. I. and Abdul Rahman, A. (2010). Malaysian Integrated 3D Cadastre registration System, In:FIG Congress, Sydney, Australia 1-16 April, 2010, pp. 14.

He, J., Li, L. and Deng. M. (2002). The design, of urban underground pipe line GIS, based on UML flexibility software developing model. In: IAPRS, Vol. XXXIV, PART2, Com II, Xi'an, Aug. 20-23, China, pp. 169-170.

ISO/TC211 (2012). ISO/TC 211 Geographic information-Land Administration Domain Model (LADM), ISO/FDIS 19152 (final draft international standard).

Kaufmann, J. and Steudler, D. (1998). Cadastre 2014 report of commission 7 working group 7.1, modern cadastres, FIG, Commission 7, Tech. Rep. 8 pages, <http://www.fig.net/cadastre2014/presentation/1998-07-kaufmannsteudler-brighton-cad2014-paper.pdf>

Lemmen, C., van Oosterom, P., Uitermark, H., Thompson, R. and Hespanha, J.P. (2009). Transforming the Land Administration Domain Model (LADM) into an ISO standard (ISO19152). FIG Working Week 2009. Eilat, Israel. http://www.gdmc.nl/publications/2009/LADM_to_ISO_Standard.pdf.

Lemmen, C., van Oosterom, P., Thompson, R., Hespanha, J.P. and Uitermark, H. (2010). The Modelling of Spatial Units (Parcels) in the Land Administration Domain Model (LADM). In: XXIV International FIG Congress, 2010, Sydney, 28 p.

Ng'ang'a, S., Sutherland, M., Cockburn, S. and Nichols, S. (2001). Toward a 3D marine Cadastre in support of good ocean governance. In: International Workshop on 3D Cadastres, 2001, Delft, pp. 99-114.

Peninga, F. and Van Oosterom, P. (2006). Kabel en leidingnetwerken in de kadastrale registratie, GIS rapport No 42, available at <http://www.gdmc.nl/publications>, 36 p. (in Dutch)

Stoter, J.E. (2004). 3D Cadastre. PhD Thesis TU Delft, Publications on Geodesy 57, Netherlands Geodetic Commission, Delft, 327 p.

Stoter, J.E. and Van Oosterom, P.J.M. (2005). Technological aspects of a full 3D cadastral registration. In: *International Journal of Geographical Information Science*, Volume 19(6), pp. 669-696.

Stoter, J.E and Van Oosterom, P.J.M. (2006). *3D cadastre in an international context: Legal, Organizational and Technological Aspects*, Taylor&Francis, ISBN 0-8493-3932-4, 323 p.

UN-HABITAT (2008). *Secure land rights for all*. Nairobi, Kenya, United Nations Human Settlements Programme: 40 p. Online available via <http://www.unhabitat.org/pmss/getElectronicVersion.aspx?nr=2488&alt=1>.

BIOGRAPHICAL NOTES

Alias Abdul Rahman is a Professor at the Department of Geoinformation and Dean of the Faculty of Geoinformation and Real Estate, Universiti Teknologi Malaysia (UTM), Skudai, Johor in Malaysia. He received a degree in Surveying and Mapping Sciences from North East London Polytechnic, England, UK in 1987, Postgrad Diploma in GIS from ITC, Netherlands, and MSc in GIS also from ITC, Netherlands. In 2000 he received his PhD degree from University of Glasgow, Scotland, U.K. Currently he serves as Chair for ISPRS Commission II/5 from 2008 – 2012 on Multidimensional GIS and Mobile Data Model.

Teng Chee Hua obtained a degree in Land Surveying in 1980 from University of Technology, Malaysia (UTM). In 1982 he received a Post-Grad Dip in Photogrammetry from ITC, The Netherlands, in 1992 received a MSc from University of New Brunswick, Canada, and a PhD from University of Newcastle, United Kingdom in 2000 for his thesis 'Object recognition assisted by GIS using expert system and ANN'. Since 1980, he has been working with the Department of Surveying and Mapping, Malaysia and involved with various projects carried out by the Department such as GDM2000, core RTKnet, precise geoid, coordinated cadastre system and eKadaster. Currently, he is the Divisional Director for Cadastre.

Peter van Oosterom obtained an MSc in Technical Computer Science in 1985 from Delft University of Technology, The Netherlands. In 1990 he received a PhD from Leiden University for this thesis 'Reactive Data Structures for GIS'. From 1985 until 1995 he worked at the TNO-FEL laboratory in The Hague, The Netherlands as a computer scientist. From 1995 until 2000 he was senior information manager at the Dutch Cadastre, where he was involved in the renewal of the Cadastral (Geographic) database. Since 2000, he is professor at the Delft University of Technology (OTB institute) and head of the section 'GIS Technology'. He is the current chair of the FIG joint commission 3 and 7 working group on '3D-Cadastres' (2010-2014).

K. H. Sharkawi, obtained an MSc degree in Geoinformatics in 2010 and a BSc degree in Geoinformatics in 2006 from Universiti Teknologi Malaysia. He is currently a PhD researcher with the 3D GIS group of the Faculty of Geoinformation and Real Estate at the Universiti Teknologi Malaysia (UTM) in Malaysia. His current research interests include 3D change detection analysis and 3D segmentation for 3D city models (CityGML).

E. E. Duncan, obtained an MSc degree in Topographic Science (Surveying) in 2000 from Glasgow University in the UK and a BSc degree in Geodetic Engineering in 1990 from the Kwame Nkrumah University of Science and Technology in Ghana. He is also a professional member of the Ghana Institution of Surveyors (MGhIS) and a lecturer (On Study leave) at the University of Mines and Technology in Ghana. He is currently a PhD researcher with the 3D GIS group of the Faculty of Geoinformation and Real Estate at the Universiti Teknologi Malaysia (UTM) in Malaysia. His current research interests include 3D spatial models for surface and subsurface objects.

Suhaibah Azri, obtained an MSc degree in Geoinformatics (3D GIS) in 2012 from Universiti Teknologi Malaysia (UTM) and a BSc degree in Geoinformatics in 2008 from the same university. Her major skills are in spatial database, 3D modelling and programming. She has been involved in various research projects and consultancies. Currently, she is a researcher in 3D GIS Research Group in the Faculty of Geoinformation and Real Estate, UTM. Her current research interests are in the area of spatial database and analysis for 3D GIS.

M. I. Hassan obtained an MSc degree from ITC, Netherlands and a BSc degree in Geoinformatics from Universiti Teknologi Malaysia. He is currently a Faculty staff and PhD researcher with the 3D GIS group of the Faculty of Geoinformation and Real Estate at the Universiti Teknologi Malaysia (UTM) in Malaysia. His current research interests include 3D Cadastres and 3D Modelling.

CONTACTS

Alias Abdul Rahman
3D GIS Research Lab
Faculty of Geoinformation and Real Estate
Universiti Teknologi Malaysia
81310 Johor Bahru
MALAYSIA
Email: alias@utm.my or alias.fksg@gmail.com

Teng Chee Hua
Cadastral Division
Department of Survey and Mapping Malaysia
Jalan Semarak, Kuala Lumpur
MALAYSIA
Email: tengcheehua@jupem.gov.my

Peter van Oosterom
Delft University of Technology
OTB Research Institute for the Built Environment
GIS Technology Section
P.O. Box 5030
2600 GA Delft

THE NETHERLANDS
Tel.: +31 15 2786950
E-mail: P.J.M.vanOosterom@tudelft.nl
Website: <http://www.gdmc.nl>

Khairul Hafiz Sharkawi
3D GIS Research Lab
Faculty of Geoinformation and Real Estate
Universiti Teknologi Malaysia
81310 Johor Bahru
MALAYSIA
Email: hafiz.sharkawi@gmail.com

Edward Eric Duncan
3D GIS Research Lab
Faculty of Geoinformation and Real Estate
Universiti Teknologi Malaysia
81310 Johor Bahru
MALAYSIA
Email: ededward2@live.utm.my or edwduncan@yahoo.com

Suhaibah Azri
3D GIS Research Lab
Faculty of Geoinformation and Real Estate
Universiti Teknologi Malaysia
81310 Johor Bahru
MALAYSIA
Email: nsuhaibah2@utm.my

M. I. Hassan
3D GIS Research Lab
Faculty of Geoinformation and Real Estate
Universiti Teknologi Malaysia
81310 Johor Bahru
MALAYSIA
Email: Imzan@utm.my

Alias Abdul Rahman, Peter Van Oosterom, Teng Chee Hua, Khairul Hafiz Sharkawi, Edward Eric Duncan,
Norsuhaibah Azri and M. Imzan Hassan
3D Modelling for Multipurpose Cadastre

3rd International Workshop on 3D Cadastres: Developments and Practices
25-26 October 2012, Shenzhen, China